

Panasonic®

Operating Instruction and Cook Book Microwave Oven Household Use Only

INVERTER



**Model Number: NN-SF574S
NN-SF564W**

Please read these instructions carefully before using this product, and save this manual for future use.

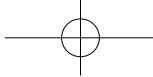

We are glad you have chosen to purchase a PANASONIC microwave oven. Before operating this oven, please read these instructions carefully and completely, and keep them for further reference.

If you have only used a microwave oven for reheating and defrosting, with Panasonic's Inverter Technology you can be reassured of excellent results when cooking a variety of foods, as the 'soft' penetration of microwave energy to the centre of food helps prevent over cooking on edges and surfaces. Foods can now be gently simmered without the concern of boil over.

After reading the introductory chapter, we are sure you will be able to master the basic techniques and thereby develop a firm understanding of your new oven. This book includes recipes from starters to desserts. After trying our recipes be sure to adapt your favourite recipes to microwave methods.

Start experimenting now, and enjoy the first class results you will achieve by using your new microwave oven.

Panasonic Australia Pty Ltd
1 Innovation Road
Macquarie Park
NSW 2113



PANASONIC NZ LTD
CUSTOMER CARE CENTRE
350 Te Irirangi Drive
East Tamaki, Auckland
Private Bag 14911
Panmure, Auckland

Phone: (09) 272-0178
Fax: (09) 272-0134

PANASONIC CORPORATION
SOUTH AFRICA
Block L North
Central Park 400, 16th Road
Midrand
1685

Phone: (011) 312-7015
Fax: (011) 312-7020

The serial number of this product may be found on the left side of the control panel. You should note the model number and serial number of this oven in the space provided and retain this book as a permanent record of your purchase for future reference.

MODEL NUMBER _____

SERIAL NUMBER _____

DATE OF PURCHASE _____

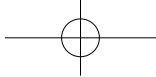

Table of Contents

Before Operation

Safety Instructions.....	2
Installation and General Instructions.....	3-5
Microwaves and How They Work.....	5
Cookware and Utensils Guide.....	6
Feature Diagram.....	7
Control Panel.....	8
Ingredient Conversion Chart.....	19

Operation and Hints

Let's Start to Use Your Oven.....	9
Display Window.....	9
To Set Clock.....	10
To Use Child Safety Lock.....	10
To Cook/Reheat/Defrost by Micro Power and Time.....	11-12
To Defrost using Turbo Defros.....	12
Defrosting Tips and Techniques.....	13
3-Stage Setting.....	14
To Reheat Food Using Reheat Meal/Frozen Reheat.....	15
To Cook Food Using Auto Cook.....	16-19
To Use Timer.....	20
Quick Guide to Operation.....	25

Maintenance

Before Requesting Service.....	21
Care of Your Microwave Oven.....	22
Technical Specifications.....	22
Panasonic Warranty.....	23-24

Cooking Guide

Microwave Recipe Techniques.....	26-28
Reheat.....	29-30
Soups and Snacks.....	31-32
Fish and Shellfish.....	33-35
Poultry and Eggs.....	36-39
Meat.....	40-43
Vegetables and Legumes.....	44-48
Rice, Pasta and Noodles.....	49-52
Cakes, Desserts and Slices.....	53-57
Sauces and Extras.....	58-60



Safety Instructions

READ CAREFULLY AND KEEP FOR FUTURE REFERENCE

Precautions to be taken when using Microwave Ovens for Heating foodstuffs

INSPECTION FOR DAMAGE. A microwave oven should only be used if an inspection confirms all of the following conditions:

1. The door fits squarely and securely and opens and closes smoothly.
2. The door hinges are in good condition.
3. The metal plates of a metal seal on the door are neither buckled nor deformed.
4. The door seals are neither covered with food nor have large burn marks.

PRECAUTIONS. Microwave radiation from microwave ovens can cause harmful effects if the following precautions are not taken:

1. Never tamper with or deactivate the interlocking devices on the door.
2. Never poke an object, particularly a metal object, through a grille or between the door and the oven while the oven is operating.
3. Never place saucepans, unopened cans or other heavy metal objects in the oven.
4. Do not let other metallic articles, e.g., fast food foil containers, touch the side of the oven.
5. Clean the oven cavity, the door and the seals with water and a mild detergent at regular intervals. Never use any form of abrasive cleaner that may scratch or scour surfaces around the door.
6. Always use the oven with trays or cookware recommended by the manufacturer.
7. Never operate the oven without a load (i.e., an absorbing material such as food or water) in the oven cavity unless specifically allowed in the manufacturer's literature.
8. For horizontally hinged doors, never rest heavy objects such as food containers on the door while it is open.
9. Do not place sealed containers in microwave ovens. Baby bottles fitted with a screw cap or a teat are considered to be sealed containers.
10. This appliance is not intended for use by persons (including children) with reduced physical, sensory or mental capabilities, or lack of experience and knowledge, unless they have been given supervision or instruction concerning use of the appliance by a person responsible for their safety.
11. Young children should be supervised to ensure that they do not play with the appliance.
12. It is hazardous for anyone other than a competent person to carry out any service or repair operation that involves the removal of a cover which gives protection against exposure to microwave energy.
13. The surfaces are liable to get hot during use.

Important Instructions

WARNING—To reduce the risk of burns, electric shock, fire, injury to persons or excessive microwave energy:

1. Read all instructions before using the microwave oven.
2. Some products such as whole eggs and sealed containers - (for example, closed glass jars **and sealed baby bottles with teat**) - may explode and should not be heated in the microwave oven.
3. Use this microwave oven only for its intended use as described in this manual.
4. As with any appliance, close supervision is necessary when used by children.
5. Do not operate this microwave oven if it is not working properly or if it has been damaged or dropped.
6. Do not store or use this appliance outdoors.
7. Do not immerse cord or plug in water.
8. Keep cord away from heated surfaces.
9. Do not let cord hang over edge of table or counter.
10. Do not remove outer panel from oven.
11. Appliances are not intended to be operated by means of an external timer or separate remotecontrol system.
12. Failure to maintain the oven in a clean condition could lead to deterioration of the surface that could adversely affect the life of the appliance and possibly result in a hazardous situation.
13. To reduce the risk of fire in the oven cavity:
 - (a) Do not overcook food. Carefully attend microwave oven if paper, plastic, or other combustible materials are placed inside the oven to facilitate cooking.
 - (b) Heating therapeutic wheat bags is not recommended. If heating, do not leave unattended and follow manufacturers' instructions carefully.
 - (c) Remove wire twist-ties from bags before placing bag in oven.
 - (d) If materials inside the oven should ignite, keep oven door closed, turn oven off at the wall switch, or shut off power at the fuse or circuit breaker panel.
 - (e) Never leave microwave unattended while cooking or reheating.

Installation and General Instructions

Earthing Instructions

This microwave oven must be earthed. In the event of an electrical short circuit, earthing reduces the risk of electric shock by providing an escape wire for the electric current. This microwave oven is equipped with a cord having an earthing wire with an earthing plug.

The plug must be plugged into an outlet that is properly installed and earthed.

WARNING—Improper use of the earthing plug can result in a risk of electric shock.

WE CERTIFY THAT THIS MICROWAVE OVEN HAS BEEN INSPECTED AND COMPLIES WITH THE REQUIREMENTS OF REGULATION 3, SUBCLAUSE(2), OF THE MICROWAVE OVENS REGULATIONS 1982.

(This statement applicable only to New Zealand.)

We certify that this microwave oven has been inspected and complies with the safety requirements of government notice 466 of March 1981, and complies with the Radio Regulation of government notice 587 of March 1986.

(This statement applicable only to South Africa)

WARNING

- a) The door seals and door seal areas should be cleaned with a damp cloth. The appliance should be inspected for damage to the door seals and door seal areas and if these areas are damaged the appliance should not be operated until it has been repaired by a qualified service technician trained by the manufacturer.
- b) It is dangerous for anyone other than a service technician trained by the manufacturer to perform repair service.
- c) If the supply cord of this appliance is damaged, it must be replaced by a qualified service technician with the special cord available only from the manufacturer.
- d) Before use, the user should check that whether the utensils are suitable for use in microwave ovens.
- e) Liquids or other foods must not be heated in sealed containers since they are liable to explode.
- f) Only allow children to use the oven without supervision when adequate instructions have been given so that the child is able to use the oven in a safe way and understands the hazards of improper use.

General Use

1. In order to maintain high quality, do not operate the oven when empty. The microwave energy will reflect continuously throughout the oven if no food or water is present to absorb energy. This can lead to damage to the microwave oven including arcing within the oven cavity.
2. If smoke is observed, press the **STOP/RESET** Pad and leave door closed in order to stifle any flames. Disconnect the power cord, and/or shut off power at the fuse or circuit breaker panel.
3. Do not dry clothes, newspapers or other materials in oven. They may catch on fire.
4. Do not use recycled paper products, unless the paper product is labelled as safe for microwave oven use. Recycled paper products may contain impurities which may cause sparks and/or fires when used.
5. Do not use newspapers or paper bags for cooking.
6. Do not hit or strike the Control Panel. Damage to controls may occur.
7. POT HOLDERS may be needed as heat from food is transferred to the cooking container and from the container to the oven. The oven can be very hot after removing the cooking container from the oven.
8. Do not store flammable materials next to, on top of, or in the oven. It could be a fire hazard.
9. Do not cook food directly on the flat table unless indicated in recipes. (Food should be placed in a suitable cooking utensil.)
10. **DO NOT** use this oven to heat chemicals or other non-food products. **DO NOT** clean this oven with any product that is labelled as containing corrosive chemicals. **The heating of corrosive chemicals in this oven may cause microwave radiation leaks.**
11. If the base of the oven is hot, allow to cool before cleaning or placing in water.
12. During cooking, some steam will condense inside and/or on the oven door. This is normal and safe. Steam will disappear after the oven cools down.
13. Do not leave the microwave unattended while reheating or cooking food in disposable containers made of plastic, paper or other combustible materials, as these types of containers can ignite if overheated.
14. The microwave oven is intended for heating food and beverages. Drying of food or clothing and heating of warming pads, slippers, sponges, damp cloth and similar may lead to risk of injury, ignition or fire.

Installation and General Instructions (continued)

Placement of Oven

1. The oven must be placed on a flat, stable surface. For correct operation, the oven must have sufficient air flow. **Allow 15 cm of space on the top of the oven, 10 cm at the back, and 5 cm on both sides. If one side of the oven is placed flush to wall, the other side or top must not be blocked. Do not remove feet.**
 - a. Do not block air vents. If they are blocked during operation, the oven may be overheated and damaged. When using any cloth over the oven, the air intake and exhaust should not be blocked. Also allow sufficient space on back and both sides of the oven.
 - b. Do not place oven near a hot or damp surface such as a gas stove, electric range or sink etc.
 - c. Do not operate oven when room humidity is too high.
2. This appliance is intended to be used in household and similar applications such as: staff kitchen areas in shops, offices and other working environments; farm house; by clients in hotels, motels and other residential environments; bed and breakfast type environments.

Building-in your oven

1. This oven is intended for counter-top and built-in use only. It is not intended for use inside a cupboard. This oven may be built into a wall cabinet by using the proper trim kit, (NN-TK510FSQP/NN-TK510FWQP) which may be purchased from your local Panasonic dealer.
2. In case of fitting into an oven housing, please use Panasonic's Trim Kit, NN-TK510FSQP/NN-TK510FWQP.
3. Microwave ovens should not be built into a unit directly above a top front venting conventional cooker. This may be a safety hazard and could result in damage to your oven. This will invalidate your one year guarantee.
4. A microwave which is built in must be more than 850 mm above floor level. Read Trim-Kit instructions carefully before installation. It is recommended that the microwave oven is placed below a conventional oven to avoid heat damage to the fascia of the microwave.

Circuits

Your microwave oven should be operated on a separate 10 A circuit from other appliances. Failure to do this may cause the power board fuse to blow, and/or food to cook slower. Do not insert higher value fuse in the power board.

Food

1. Do not use your oven for home canning or the heating of any closed jar. Pressure will build up and the jar may explode. In addition, the microwave oven cannot maintain the food at the correct canning temperature. Improperly canned food may spoil and be dangerous to consume.
2. Do not attempt to deep fat fry in your microwave oven.
3. Do not boil eggs in their shell and whole hard-boiled eggs (unless otherwise stated in Cooking Guide section). Pressure will build up and the eggs will explode.
4. Potatoes, apples, egg yolks, chicken wings, whole squash and sausages are examples of foods with nonporous skins. This type of food must be pierced before cooking, to prevent bursting.
5. When heating liquids, e.g. soup, sauces and beverages, in your microwave oven, overheating the liquid beyond boiling point can occur without evidence of bubbling. This could result in a sudden boil over of hot liquid. To prevent this possibility the following steps should be taken:
 - a) Avoid using straight-sided containers with narrow necks.
 - b) Do not overheat.
 - c) **Stir** the liquid before placing the container in the oven and halfway through cooking time.
 - d) After heating, allow to stand in the oven for a short time, stirring again before carefully removing the container.
6. **DO NOT USE A CONVENTIONAL MEAT THERMOMETER IN THE MICROWAVE OVEN. To check the degree of cooking of roasts and poultry use a MICROWAVE THERMOMETER.** Alternatively, a conventional meat thermometer may be used after the food is removed from the oven. If undercooked, return meat or poultry to the oven and cook for a few more minutes at the recommended power level. It is important to ensure that meat and poultry are thoroughly cooked.
7. **COOKING TIMES given in the Cooking Guide section are APPROXIMATE.** Factors that may affect cooking time are preferred degree of moisture content, starting temperature, altitude, volume, size, shape of food and utensils used. As you become familiar with the oven, you will be able to adjust for these factors.
8. **It is better to UNDERCOOK RATHER THAN OVERCOOK foods.** If food is undercooked, it can always be returned to the oven for further cooking. If food is overcooked, nothing can be done. Always start with minimum cooking times recommended.



Installation and General Instructions (continued)

9. Extreme care should be taken when cooking popcorn in a microwave oven. Cook for minimum time as recommended by manufacturer. Use the directions suitable for the wattage of your microwave oven. NEVER leave oven unattended when popping popcorn.
10. When heating food in plastic or paper containers, check the oven frequently due to the possibility of ignition.
11. The contents of feeding bottles and baby food jars are to be stirred or shaken and the temperature is to be checked before consumption, in order to avoid burns.

Microwaves and How They Work

Microwaves are a form of high frequency radio waves similar to those used by a radio, including AM, FM and CB. They are similar to a television where the radio waves are converted to a picture on the screen. However, microwaves are much shorter than radio waves; approximately twelve centimetres wave length. Electricity is converted into microwave energy by the magnetron tube (which is the heart of the microwave oven).

From the magnetron tube, microwave energy is transmitted to the oven cavity through a small plastic covered piece. The microwaves are converted to heat in the food. The microwaves enter from the outside of the food and travel through the food losing half of their power every two to three centimetres. Continued cooking to the centre occurs by conduction.

Although pacemakers used to be affected by microwaves (as well as by other radio waves), they are now shielded and are not bothered by these interferences. This allows people with pacemakers to sit calmly by their radio or television and cook with microwave ovens.

When microwaves come in contact with a substance, any one or combination of three things may occur.

They can be:

1. REFLECTED
2. TRANSMITTED
3. ABSORBED

Reflection:

Metal substances REFLECT microwave energy and because there is no absorption, there is no heating. This is why the oven interior is either stainless steel or epoxy-coated steel. This ensures that the microwaves are kept inside the cavity and evenly distributed throughout the food with the help of the turntable.

Transmission:

Such substances as paper, glass and plastic TRANSMIT microwave energy and do not become hot except from food. Because these substances do not reflect or absorb microwave energy, they are ideal materials for microwave cooking containers.

Absorption:

Food contains moisture and will ABSORB microwave energy, which causes the moisture molecules within the food to vibrate at an incredible rate (2,450,000,000 times per second). Friction, created by the vibration, produces heat energy which is conducted throughout the food.

Cookware and Utensils Guide

It is important to use the correct container when cooking in a microwave oven. The following will help you make the right selection.

How to Test a Container for Safe Microwave Oven Use

TO TEST A CONTAINER FOR SAFE MICROWAVE OVEN USE: Fill a 1-cup glass measure with cool water and place it in the microwave oven alongside the empty container to be tested; **heat one (1) minute at High**. If the container is microwave oven safe (transparent to microwave energy), the container should remain comfortably cool, the water in glass measure should be hot. If the container is hot, it has absorbed some microwave energy and should NOT be used. This test cannot be used for plastic containers.

Paper Products and Freezer Wrap

Waxed paper, paper plates, cups and napkins should not be used for heating or cooking food. Freezer wrap should not be used as it is not heat resistant and may melt. Paper towel, greaseproof paper and bake paper may be safely used for short periods of time for covering or lining.

Glass, Ceramic and China

Heat-Resistant glass cookware is invaluable in microwave cooking. Many of these items are readily available in most homes: glass jugs, mixing bowls, loaf dishes, covered casseroles, oblong baking dishes, pie plates and round or square cake dishes. Examples of this type of cookware are Pyrex® and Corningware®.

Dinnerware can be used for microwave heating. Many brands of dinnerware are microwave safe. Check the care information for reference to microwave use for dinnerware and serving pieces. If dinnerware is marked ovenproof, it frequently is safe to use in the microwave oven. However, to be sure, check by conducting microwave dish test previously mentioned.

Several types of glassware and dinnerware are not recommended for use in the microwave oven. Do not use dishes with metallic trim or containers with metal parts. Do not use cups or mugs with glued on handles, as they may fall off with continued heating. Do not use delicate glassware. Although the glassware may be transparent to microwave energy the heat from the food may cause the glassware to crack.

Plastics

Plastic dishes, cups and some freezer containers should be used with care in a microwave oven. Choose plastic containers carefully, as some plastic containers may become soft, melt and may scorch. The majority of plastic dishes, even those designed for use in the microwave oven, are not suitable for cooking foods with high fat or sugar content, or for lengthy cooking times. Most microwave plastic dishes should not be used for longer than 3 to 5 minutes on **High** power. These dishes, although not suitable

for extended cooking, may be used successfully for defrosting or for use on lower power levels.

Cooking Bags designed to withstand boiling, freezing, or conventional heating are microwave safe. Prepare bags according to manufacturer's directions. When cooking by microwave, **DO NOT** use wire twist-ties to close bag. They can act as an antenna and cause arcing (sparks).

DO NOT COOK IN PLASTIC FOOD STORAGE BAGS.

Plastic Wrap such as GLAD WRAP® can be used to cover dishes in most recipes. Over an extended heating time, some disfiguration of the wrap may occur. When removing plastic wrap "covers", as well as any glass lid, be careful to remove it away from you to avoid steam burns.

Loosen plastic but let dish stand, covered.

Jars and Bottles

Jars and bottles can be used to warm food to serving temperature, if the lid is removed first. Cooking should not be done in these containers since most are not heat resistant and during extended heating times, heat from food would cause cracking or breaking.

Metal

Metal cookware or utensils, or those with metallic trim, should NOT be used in the microwave. Since microwave energy is reflected by metal, foods in metal containers will not cook evenly. There is also a possibility of "arcing".

Although metal utensils should be avoided in microwave cooking, some metal can be helpful when used correctly.

Aluminum foil can be used safely, if certain guidelines are followed, to prevent overcooking. Small pieces of foil are used to shield areas such as chicken wings, tips of roasts, or other thin parts that cook before the rest of the recipe is finished. Make sure foil is attached securely and doesn't touch sides of oven, otherwise arcing may occur. Foil lined containers, either cardboard or plastic, should NOT be used in the microwave oven as arcing could occur.

Metal twist-ties, either paper or plastic coated, should NOT be used in the microwave oven. Frozen dinner trays can be used in the microwave, if the container is no deeper than 2 cm and is filled with food. Metal skewers can not be used in microwave ovens as arcing may occur. Wooden skewers are readily available and give the same result.

Shells: Scalloped baking shells are best used during reheating and for short periods of cooking time only.

Thermometers are available for use in microwave ovens. **DO NOT USE CONVENTIONAL MERCURY TYPE CANDY OR MEAT THERMOMETERS** in food while cooking in the microwave oven.

Straw, Wicker and Wood

Straw and wicker baskets may be used in the microwave oven for short periods of time to warm rolls or bread. Large wooden utensils, such as bowls or cutting boards should NOT be used for prolonged heating as the microwave energy may cause the wood to become dry and brittle.

Feature Diagram

Flat Table

1. If the flat table is hot, allow to cool before cleaning.
2. **Do not** cook directly on the flat table. Always put the food in the container special for the microwave oven.

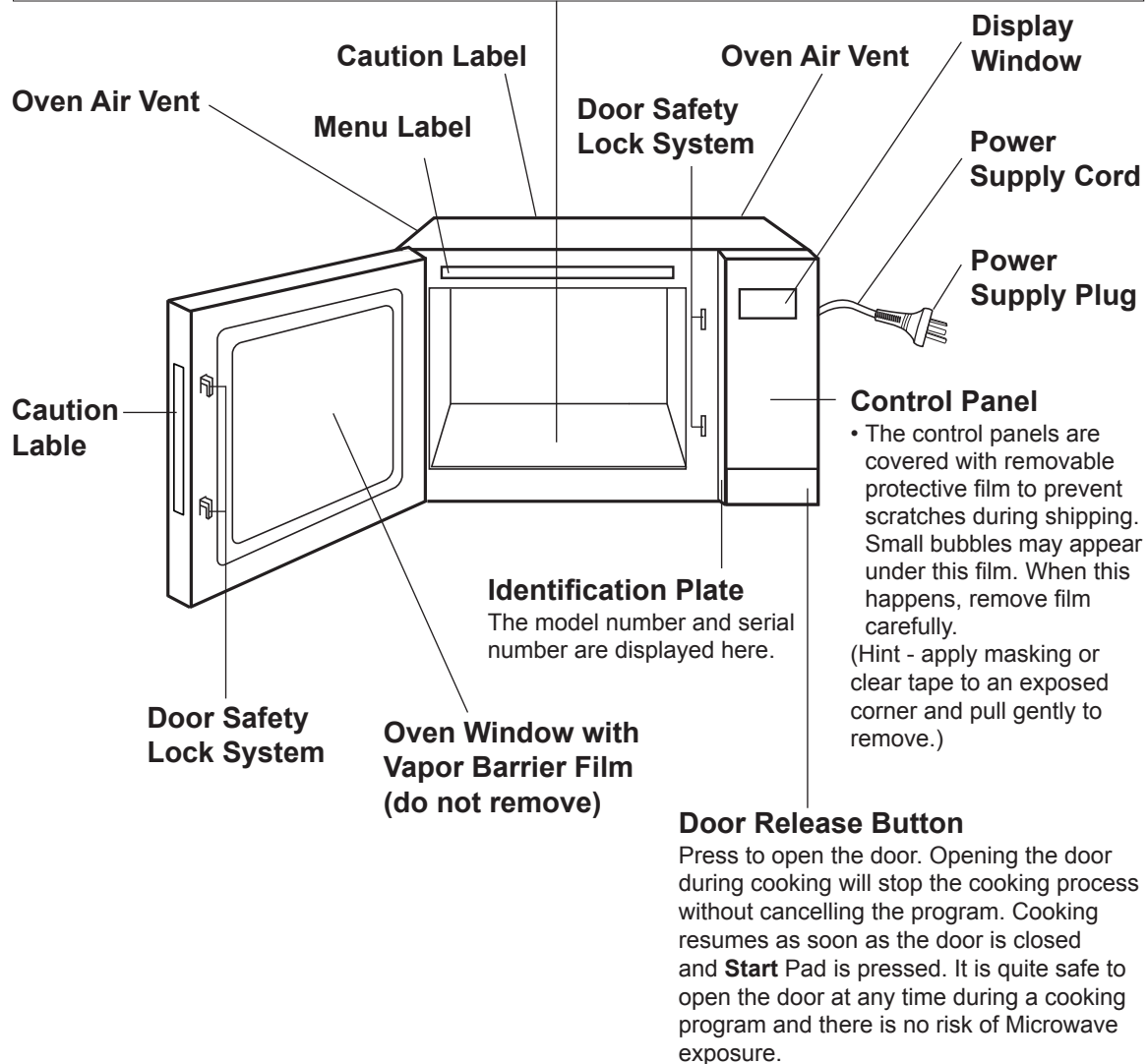

Oven Light:

Oven Light will turn on during cooking and also when door is opened.

NOTE:

The above illustration is for reference only.

Control Panel

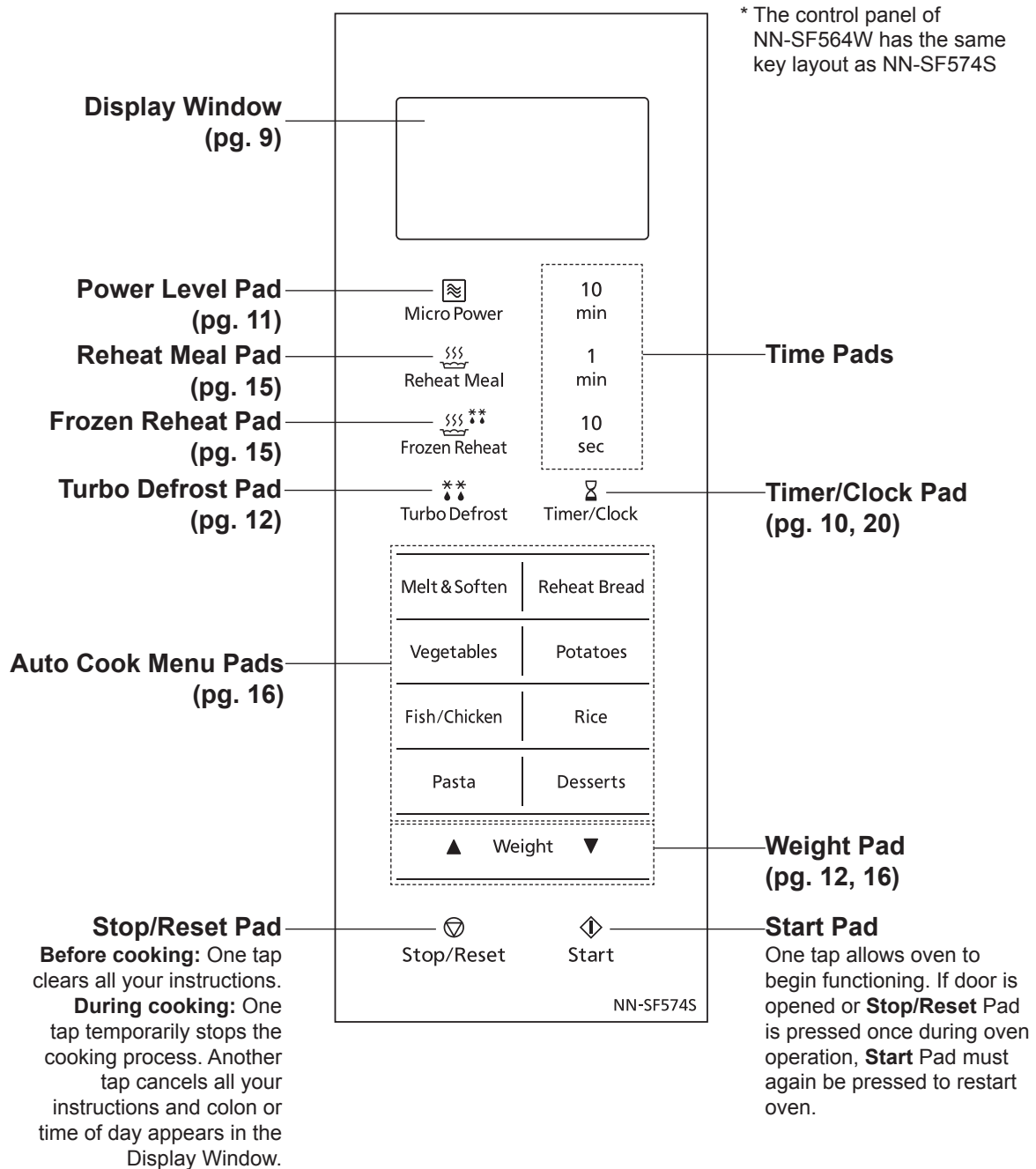

* The control panel of NN-SF564W has the same key layout as NN-SF574S

Beep Sound

When pad is pressed correctly, a beep sound will be heard. If a pad is pressed and no beep is heard, the unit does not or cannot accept the instruction. The oven will beep twice between programmed stages. At the end of any complete programme, the oven will beep five times.

NOTE:

If an operation is set and **Start** Pad is not pressed, after 6 minutes, the oven will automatically cancel the operation. The display will revert back to clock or colon mode.

Let's Start To Use Your Oven!

1 Plug in

Plug into a properly earthed electrical outlet. "88:88" appears in the Display Window. (This will immediately cease when any pad is pressed.)

2 Open Door

Open the door and place container with food at the center of flat table. Then close the door.

3 Select Power Level

E.g. Med-High
Press **Micro Power** Pad twice.
(see page 11 for Micro Power chart)

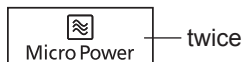

4 Set Time

E.g. 13 minute 20 seconds
Press **Time Pads**

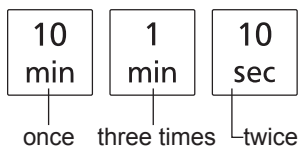

5 Press



Cooking will start.
The time in the Display Window will count down.

Display Window

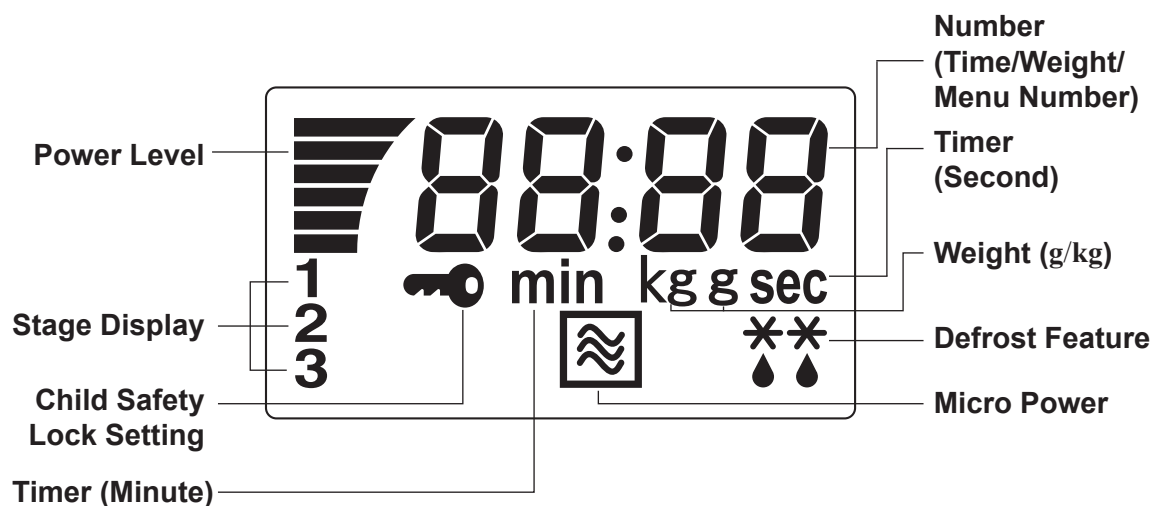

To Set Clock

You can use the oven without setting the clock.

1 Press twice

Colon will blink in Display Window.

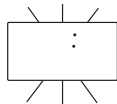

2 Enter Time of Day

Enter time of day using **Time Pads**.

E.g. 12:35:

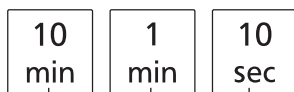

12 times 3 times 5 times

Time appears in the Display Window, colon is blinking.

Verify time of day in the Display Window.

3 Press

Colon stops blinking; time of day is entered and locked into Display Window.

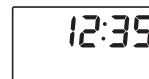

NOTES:

1. Oven will not operate while colon is still blinking.
2. To reset time of day, repeat step 1 through 3.
3. The clock will keep the time of day as long as oven is plugged in and electricity is supplied.
4. Clock is a 12 hour display. There isn't a.m. or p.m. setting.
5. Maximum time available is 12:59. Clock is 12 hour only. One o'clock will be displayed as 1:00 not 13:00.

To Use Child Safety Lock

This feature allows you to prevent operation of the oven by a young child; however, the door will open. You can set Child Safety Lock when colon or time of day is displayed.

To set

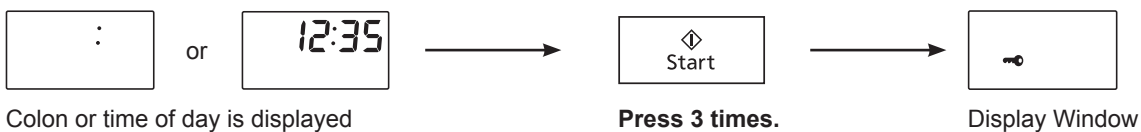

To cancel

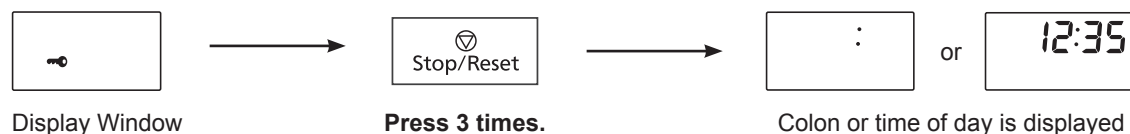

NOTE:

To set or cancel child safety lock, **Start** pad or **Stop/Reset** pad must be pressed 3 times within 10 seconds.

To Cook/Reheat/Defrost by Micro Power and Time

1 Select Power Level

Press **Micro Power** pad until your desired power level appears in the Display Window. (see chart below)



Note: When selecting High on the first stage, you can start from step 2.

2 Set Cooking Time

Enter cooking time using **Time Pads**.

E.g. 5 minutes

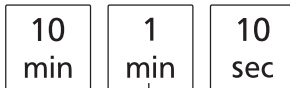

5 times

Maximum Length of cooking time:

High power: up to 30 minutes, other powers: up to 99 minutes and 50 seconds for a single stage

3 Press



Cooking will start.

The time in the Display Window will count down.

For more than one stage cooking,













Repeat steps 1 & 2 above then press **Start**. The maximum number of stages for cooking is 3. The oven will beep twice between stages. For the details, please refer to page 14.

Micro Power:

The **Power Level** Pad gives you a selection of different power levels representing decreasing amounts of microwave energy, used for cooking foods at different speeds.

E.g. The lower the micro power setting, the more evenly the food cooks, although it will take a little longer.

To select the correct power level for cooking different foods, refer to the chart below.

Press	POWER LEVEL	WATTAGE	DISPLAY	EXAMPLE OF USE
1x	HIGH	1000 W	 	Boil water. Reheat. Cook vegetables, rice, pasta and noodles.
2x	MED-HIGH	700 W	 	Cook poultry, meat, cakes, desserts. Heat milk.
3x	MEDIUM	600 W	 	Cook beef, lamb, eggs, fish and seafood. Melt butter.
4x	MED-LOW	450 W	 	Simmer soups, stews and casseroles (less tender cuts).
5x	DEFROST	350 W	  **	Defrost meat, poultry and seafood.
6x	LOW	250 W	 	Keep cooked foods warm, simmer slowly.

NOTE:

After using the oven, the fan may rotate to cool the electric components and "COOL" appears in the display window. If you cook using microwave, "COOL" will appear after micro cooking over 3 minutes. This is perfectly normal, and you can take out the food from the oven while the fan operates.

To Defrost

To Defrost using Turbo Defrost

This feature allows you to defrost meat, poultry and seafood automatically by just setting the weight of the food.

1 Press  Turbo Defrost

until the desired weight appears in the Display Window.

The shape and size of the food will determine the maximum weight the oven can accommodate. The recommended maximum weight of food depends on the oven cavity size. Weight must be programmed in kilograms and tenths of a kilogram (0.1 kg ~ 3.0 kg). For best results, the minimum recommended weight is 0.2 kg.

2 Press  Start

Defrost time appears in the Display Window and begins to count down.

NOTES:

1. After you select the Turbo Defrost feature, you can also press **Weight** pad to select weight before pressing **Start**.
2. The oven will beep once or twice during the total defrosting time. This indicates that food should be turned, broken apart or removed. After attending to food, close door and press **Start** to resume defrosting.
3. For further information, refer to next page.

To Defrost by Micro Power and Time Setting

This feature allows you to defrost meat, poultry and seafood by **Defrost Power** and time.

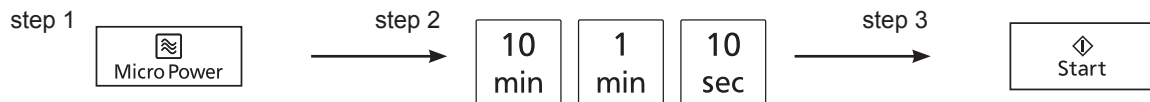

Press 5 times to select Defrost power level, refer to page 11

Set time according to chart on next page.

Press

NOTES:

1. Please use plastic wrap or lids when defrosting.
2. Opening the door and taking out the defrosted parts during the operating time is recommended. Turn over, stir or rearrange the parts which are still in icy.

Defrosting Tips and Techniques

Preparation for Freezing:

1. Heavy-duty plastic wraps, bags and freezer wrap are suitable.
2. Freeze meats, poultry and fish in packages with only 1 or 2 layers of food. To aid in separating layers, place two pieces of wax paper between them.
3. REMOVE ALL AIR and seal securely.
4. LABEL package with type and cut of meat, date and weight.
5. Defrosting times given in the charts are for thoroughly frozen foods (i.e. at least 24 hours in freezer maintained at -18 °C or lower).

Defrosting Technique:

1. Remove from wrapper and set on a defrosting rack in a dish on the flat table.
2. On Turbo Defrost, the oven will beep during the defrosting time. At "beep", turn over all meat, poultry, fish and shellfish. Break apart stewing meat, chicken pieces and minced meat. Separate chops and hamburger patties. Shield thin ends of roasts, poultry legs and wings, fat or bones with foil.
3. Throughout the defrosting time, remove any defrosted portions of mince or cubed meat, etc.
4. After defrosting, large roasts may still be icy in the centre. Let stand, 15 to 30 minutes, in refrigerator to complete defrosting.

Defrosting Chart (by setting Micro Power at Defrost Power):

FOOD	APPROX. TIME (minutes per 500 g)	INSTRUCTION
MEAT		
Beef		Halfway through the defrost cycle, break apart minced beef, separate chops and remove meat that is defrosted.
Minced Beef	6 - 7	
Roast: Topside	7 - 8	
Beef Tenderloin	7 - 8	
Chuck or Rump	7 - 8	
Sirloin, rolled	7 - 8	Turn meat over two to three times during defrosting.
Steak	5 - 6	
Miscellaneous	6 - 7	Shield edges and unevenly shaped ends of roasts halfway through the defrost cycle.
Pork/Lamb		
Roast	7 - 9	Large roasts may still be icy in centre. Let stand.
Chops	5 - 6	
Ribs	5 - 6	
POULTRY		
Chicken		Turn poultry over two to four times during defrosting. Halfway through the defrost cycle, shield end of drumsticks, wings, breast bones and ends of poultry with foil.
whole	5 - 6	
pieces	6 - 7	
fillets	5 - 6	
Duck	6 - 7	Break apart chicken pieces and remove small pieces such as wings, which may be defrosted before larger pieces.
Turkey	7 - 9	
		Rinse poultry under cold water to remove ice crystals. Let stand 5 to 10 minutes, before cooking.
FISH & SHELLFISH		
Fish Fillets	4 - 5	Halfway through the defrost cycle, turn whole fish or blocks of fillets over. Also, break apart prawns or scallops. Remove any pieces that are defrosted.
Whole Fish	3 - 4	
Crabmeat	3 - 4	
Lobster Tails	3 - 4	
Sea Scallops	3 - 4	
Green Prawns	3 - 4	Let stand, 5 to 10 minutes, before cooking.

3-Stage Setting

This feature allows you to program 3 Stages of cooking continuously.

E.g.: Continually set [MED-HIGH] 2 minutes, [Medium] 3 minutes and [Low] 2 minutes.

1. Press twice to select "MED-High".



2. Set as 2 minutes using Time Pads.

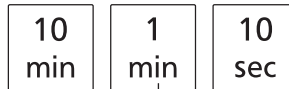

twice



3. Press 3 times to select "Medium".



4. Set as 2 minutes using Time Pads.

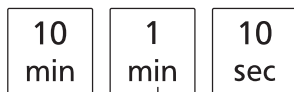

twice



5. Press 6 times to select "Low".



6. Set as 3 minutes using Time Pads.

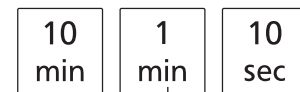

3 times



7. Press once. The time will count down at the first stage in the display window.

NOTES:

1. When selecting High power on the first stage, you can skip step 1.
2. When operating, two beeps will sound between each stage.
3. This feature is not available for Turbo Defrost, Auto Cook and Reheat function.

To Reheat Food Using Reheat Meal/Frozen Reheat

1 Press  Reheat Meal **OR**  Frozen Reheat

until the desired weight appears in the Display Window.

Food Category Pad	Serving / Weight			
	1 tap	2 taps	3 taps	4 taps
Reheat Meal	1 serve	2 serves	3 serves	4 serves
Frozen Reheat	100 g	150 g	200 g	250 g

2 Press  Start

Reheating time appears in the Display Window and begins to count down.

NOTE:

After you select the reheat menu, you can also press Weight pad to select weight before pressing Start

For best results on Auto Reheat, follow these recommendations:

Reheat Meal (1 - 4 Serves)

- All foods must be pre-cooked. Suitable for casseroles, plated dinners, soups, stews, pasta dishes (except lasagne), and canned foods.
- **Do not** reheat bread or pastry products; raw; uncooked or frozen foods; or beverages.
- Foods should be reheated from room temperature or refrigerator temperature. **Do not** reheat frozen foods on this setting.
- Foods should be covered loosely but completely with plastic wrap or a casserole lid which does not snap seal.
- Foods weighting less than 200 g and more than 800 g should be reheated by Micro Power and Time only.
- All foods should have a covered stand time of 3 to 5 minutes at the end of reheating.
- At the end of the cooking time, stir and let stand for 3 to 5 minutes.

Frozen Reheat (100 g - 250 g)

- It is suitable for cooking different kinds of frozen vegetables.
- Put them in a microwave safe container, add water if you prefer a softer cooked texture.
- Cover with the lid and place container at the center of the flat table.
- Select the program and weight then press Start.
- Add salt and other seasonings after cooking, then stir.

To Cook Food Using **Auto Cook**

1 Press Desired Food Category Pad

Select and press the appropriate pad for the food you are cooking. The number of category appears in the Display Window.

E.g.: Jacket Potatoes Potatoes — once

2 Press Weight Pad ▲ Weight ▼

Press Weight Pad until the desired food Serving/Weight appears in the display window. (see below chart)

Auto Cook Pad	Food Category	Serving / Weight					
		1 tap	2 taps	3 taps	4 taps	5 taps	6 taps
Melt & Soften	1.Chocolate	50 g	100 g	150 g	200 g	250 g	300 g
	2.Butter	50 g	100 g	150 g	200 g	250 g	300 g
	3.Cheese	50 g	100 g	150 g	200 g	250 g	300 g
	4.Ice Cream	200 g	500 g	1000 g	2000 g	-	-
Reheat Bread	5.Reheat Bread	100 g	200 g	300 g	500 g	-	-
Vegetables	6.Vegetables	100 g	200 g	300 g	400 g	-	-
	7.Frozen Vegetables	120 g	250 g	500 g	700 g	-	-
Potatoes	8.Jacket Potatoes	250 g	370 g	500 g	900 g	-	-
	9.Root Vegetables	180 g	250 g	370 g	500 g	-	-
Fish/Chicken	10.Steam Fish	100 g	200 g	300 g	400 g	-	-
	11.Steam Chicken Pieces	100 g	200 g	300 g	400 g	-	-
Rice	12.Rice	1 Cup	1.5 Cups	2 Cups	2.5 Cups	-	-
	13.Risotto	0.5 Cup	1 Cup	2 Cups	3 Cups	-	-
Pasta	14.Pasta	150 g	250 g	350 g	500 g	-	-
	15.Instant Noodle	1 Serv.	2 Serv.	-	-	-	-
Desserts	16.Fruit	150 g	250 g	500 g	700 g	-	-
	17.Pudding	2 Serv.	4 Serv.	-	-	-	-

3 Press ↕ Start

Cooking time appears in the Display Window and begins to count down.

For best results on Auto Cook, follow the recommendations on next page.

To Cook Food Using **Auto Cook** (continued)

1. Chocolate

Remove wrapper and place chocolate into a microwave safe dish. Cook without cover. After heating, stir until completely melted.

Note: Chocolate holds its shape even when softened. If food needs more time cooking or weight exceeds range, cook using Defrost power for melting

2. Butter

Remove wrapper, cut butter into 2 tbsp cube, and place into a microwave safe dish. Melt with lid or plastic wrap. Stir after cooking. If food needs more time cooking or weight exceeds range, cook using Defrost power for melting

3. Cheese

Remove wrapper and place in a microwave safe bowl/dish. Soften without cover. If food needs more time cooking or weight exceeds range, cook using Low power for softening.

4. Ice Cream

Soften slightly without lid. If food needs more time cooking or weight exceeds range, cook using Low power for softening.

5. Reheat Bread

It is suitable for reheating bread at refrigerator temperature (5-7 °C). Put the bread on a suitable size microwave safe dish and place container at the center of the flat table. Select the program and weight then press **Start**. **DO NOT USE PLASTIC WRAP OR LID.**

Note: 50 g = one standard slice of bread.

6. Vegetables

It is suitable for cooking different kinds of leaf vegetables. Clean the vegetables and place them in a microwave safe container, add some oil and stir. Cover with a lid or plastic wrap and place container at the center of the flat table. Select the program and weight then press **Start**. Add salt and other seasonings after cooking, then stir.

7. Frozen Vegetables

It is suitable for cooking different kinds of frozen vegetables. Put them in a microwave safe container, add water if you prefer a softer cooked texture. Cover with a lid or plastic wrap and place container at the center of the flat table. Select the program and weight then press **Start**. Add salt and other seasonings after cooking, then stir.

8. Jacket Potatoes

It is suitable for cooking potatoes. For best result, please keep potato 150-200 g each. Put a light cross-notch on the surface of potatoes with a kitchen knife. Arrange prepared potatoes in a microwave safe container and place it at the center of the flat table. Select the program and weight then press **Start**. Open the door to **TURN OVER AND ARRANGE WHEN TWO BEEPS HEARD** during cooking, press **Start** Pad to continue. **DO NOT USE PLASTIC WRAP OR LID.**

9. Root Vegetables

It is suitable for cooking root vegetables such as potato and carrot. Cut them into pieces and arrange them in a microwave safe container, add water if you prefer a softer cooked texture. Cover with a lid or plastic wrap and place container at the center of the flat table. Select the program and weight then press **Start**. Open the door to **STIR WHEN TWO BEEPS HEARD** during cooking, press **Start** Pad to continue. Add salt and other seasonings after cooking, then stir.

10. Steam Fish

It is suitable for cooking whole fish and fish fillets (thickness of fish should not be more than 3 cm). Select fish suitable for microwave cooking and place in a single layer in a microwave safe dish, with skin-side down. Add butter, spices, herbs, or lemon juice to flavor. Overlap thin edges of fillets to prevent overcooking. If stuffing whole fish with seasoning, cooking time may need to be extended. Shield the eye and tail area of whole fish with small amounts of aluminum foil to prevent overcooking. Cover dish securely with plastic wrap or fitted lid and place container at the center of the flat table. Select the program and weight then press **Start**. Allow large amounts of fish to stand for 3 to 5 minutes after cooking before serving.

11. Steam Chicken Pieces

It is suitable for chicken piece, such as wings, drumsticks, thighs, half breast etc. Pierce the chicken pieces and marinate with gravy if needed. Put the prepared chicken pieces onto a microwave safe dish. Cover with a lid or plastic wrap and place container at the center of the flat table. Select the program and weight then press **Start**. **Open the door to STIR WHEN TWO BEEPS HEARD** during cooking, press **Start** Pad to continue.

12. Rice

It is suitable for cooking plain rice. Put rice in a suitable sized microwave safe dish with tap water. See chart below.

Rice	Water
1 cup	300 ml
1.5 cups	380 ml
2 cups	600 ml
2.5 cups	900 ml

Always allow at most ½ depth of volume for evaporation to prevent boiling over. Cover with a lid or plastic wrap and place container at the center of the flat table. Select the program and weight then press **Start**. Allow rice to stand for 5-10 minutes after cooking.

To Cook Food Using **Auto Cook** (continued)

13. Risotto

Suitable for cooking many basic risotto recipes and variations. Onions and garlic should be pre-cooked with 1 tablespoon of oil before adding rice and stock. Follow general directions in chart below for quantities of rice and amounts of stock. Always use arborio rice or shortgrain rice. Chicken, vegetable, beef or fish stock may be used. Stock should be boiling when added to rice otherwise cooking times may be incorrect. Cover dish securely with a lid or plastic wrap at stage 1. During the cooking time the oven will beep and instruct you to add liquid/stir. Remove a lid or plastic wrap completely from dish. Add remaining stock. There is no need to re-cover for stage 2. At the end of stage 2 add grated parmesan cheese, stir through and cook for 2 to 4 minutes on High. Standing time may be required at the end to allow risotto to finish cooking.

General Quantities For Cooking Risotto:

	Pre cook	Stage 1		Stage 2	Stage 3
	High for 1 to 2 min. (all quantities)	Rice	Boiling Stock	Boiling Stock	High for 2 to 4 min.
0.5 cup	½ onion 1 clove garlic 1 tbsp. Oil	0.5 cup	200 ml	200 ml	2 tablespoons parmesan
1 cup	1 onion 1 cloves garlic 1 tbsp. Oil	1 cup	400 ml	400 ml	2 tablespoons parmesan
2 cups	1 onions 2 cloves garlic 2 tbsp. Oil	2 cups	650 ml	650 ml	¼ cup parmesan
3 cups	2 onions 3 cloves garlic 3 tbsp. Oil	3 cups	850 ml	850 ml	⅓ cup parmesan

14. Pasta

It is suitable for cooking a variety of pastas such as spaghetti, fettuccine, tagliatelle, macaroni, penne, spiral and various pasta shapes. Place the pasta into a suitable sized microwave safe dish with boiling water. See chart below.

Pasta	Boiling Water	Dish Size
150 g	4 cups	3 litre
250 g	5 cups	3 litre
375 g	6 cups	4 litre
500 g	8 cups	4 litre

Add 1 tablespoon of oil, if desired, before cooking to prevent the pasta from sticking together. Cover with plastic wrap or a fitted lid. Place container at the center of the flat table. Select the program and weight then press **Start**. Open the door to **STIR WHEN TWO BEEPS HEARD** during cooking, press **Start** Pad to continue. Allow pasta to stand for 5 to 10 minutes after cooking if required then drain.

15. Instant Noodle

It is suitable for cooking instant noodle. Place the instant noodle and seasoning in a suitable size microwave safe casserole with boiling water. See chart below.

Instant Noodle	Boiling Water
1 Serv.	500 ml
2 Serv.	800 ml

Allow at least ½ depth of volume for evaporation to prevent boiling over. Cover with lid and place container at the center of the flat table. Select the program and weight then press **Start**. Open the door to **STIR WHEN TWO BEEPS HEARD** during cooking, touch **Start** Pad to continue.

To Cook Food Using **Auto Cook** (continued)

16. Fruit

It is suitable for cooking fruits that would usually be stewed or poached. Fruits such as apples, stone fruits, pears, figs, pineapple, kiwi fruit and berries can be used. Trim and cut fruit into even sized pieces. Place all ingredients into a microwave safe container. See chart below for quantities.

Fruit	Water	Sugar
150 g	75 ml	$\frac{1}{8}$ cup
250 g	125 ml	$\frac{1}{4}$ cup
500 g	250 ml	$\frac{1}{2}$ cup
700 g	350 ml	$\frac{3}{4}$ cup

Stir to dissolve sugar. Spices can be added if desired. Cook covered with a lid or plastic wrap and place container at the center of the flat table. Select the program and weight then press **Start**. Open the door to **STIR WHEN TWO BEEPS HEARD** during cooking, press **Start** Pad to continue.

17. Pudding

It is suitable for cooking individual steamed sponge puddings. Use packet mixes available from supermarkets or individual recipes. Not suitable for heavy fruit type puddings. See chart below for 4 serv.

self raising flour	1 cup
cocoa powder	1 tablespoon
caster sugar	$\frac{1}{3}$ cup
milk	$\frac{3}{4}$ cup
vanilla essence	1 teaspoon
chocolate	50 g
butter	100 g
brown sugar	$\frac{3}{4}$ cup
cocoa, extra	2 tablespoons
water	$\frac{1}{2}$ cup

Sift flour and cocoa into a bowl. Add sugar, milk and vanilla essence. Mix well and set aside. Melt chocolate and butter in a separate microwave safe container and pour it into the mixture while hot. Mix well. Combine brown sugar, cocoa and water in a jug. Spread all the mixture into base of a 2-litre casserole dish. Select the program and weight then press **Start**. Do not use plastic wrap or lid.

Ingredient Conversion Chart

$\frac{1}{4}$ cup	60 ml	$\frac{1}{4}$ teaspoon	1 ml
$\frac{1}{3}$ cup	85 ml	$\frac{1}{2}$ teaspoon	2 ml
$\frac{1}{2}$ cup	125 ml	1 teaspoon	5 ml
$\frac{2}{3}$ cup	165 ml	2 teaspoons	10 ml
$\frac{3}{4}$ cup	190 ml	3 teaspoons	15 ml
1 cup	250 ml	1 tablespoon	20 ml
1 $\frac{1}{4}$ cups	310 ml	1 $\frac{1}{2}$ tbs	30 ml
1 $\frac{1}{2}$ cups	375 ml	2 tbs	40 ml
2 cups	500 ml	3 tbs	60 ml
3 cup	750 ml	4 tablespoons	80 ml
3 $\frac{1}{2}$ cups	875 ml		
4 cups	1 litre		
6 cups	1.5 litre		
8 cups	2 litre		

All recipes are tested using standard measurement that appear in the above chart.

To Use Timer

This feature allows you to program standing after cooking is completed and to program the oven as a minute or a second timer or program delay start.

To Use as a Kitchen Timer

Press once.



Set desired amount of time.
(up to 99 minutes and 50 seconds)

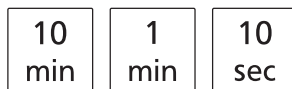

Press Start.

Time will count down without oven operating.



To Set Standing Time

Press once.

Set the desired cooking programme.
(see Page 11)



Set desired amount of standing time.
(up to 99 minutes and 50 seconds)

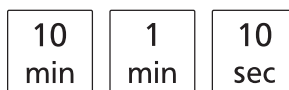

Press Start.

Cooking will start. After cooking, standing time will count down without oven operating.



To Set Delay Start

Press once.

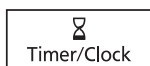

Set desired amount of delay time.
(up to 99 minutes and 50 seconds)

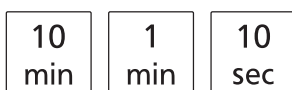

Set the desired cooking programme.
(see Page 11)

Press Start.

Delayed time will count down without oven operating. Then cooking will start.



NOTES:

1. If oven door is opened during the Standing Time, Delay Start or Kitchen Timer, the time in the Display Window will continue to count down.
2. Delay Start/Standing Time cannot be programmed before/after any Auto Control function. This is to prevent the standing temperature of the food from rising before defrosting or cooking begins. A change in the starting temperature could cause inaccurate results and/or food may deteriorate.
3. When using Standing time or Delay Start, it's up to 2 Power stages.

Before Requesting Service

THESE THINGS ARE NORMAL

The oven causes interference with my TV.

Some radio and TV interference might occur when you cook with the microwave oven. This interference is similar to the interference caused by small appliances such as mixers, vacuums, hair dryers, etc. It does not indicate a problem with your oven.

Steam accumulates on the oven door and warm air comes from the oven vents.

During cooking, steam and warm air are given off from the food. Most of the steam and warm air are removed from the oven by the air which circulates in the oven cavity. However, some steam will condense on cooler surfaces such as the oven door. This is normal.

I accidentally ran my microwave oven without any food in it.

Running the oven empty for a short time will not damage the oven. However, we do not recommend this.

PROBLEM

POSSIBLE CAUSE

REMEDY

Oven will not turn on.

The oven is not plugged in securely.

Remove plug from outlet, wait 10 seconds and re-insert.

Circuit breaker or fuse is tripped or blown.

Reset circuit breaker or replace fuse.

There is a problem with the outlet.

Plug another appliance into the outlet to check if the outlet is working.

Oven will not start cooking.

The door is not closed completely.

Close the oven door securely.

Start Pad was not pressed after programming

Press **Start** Pad.

Another program has already been entered into the oven.

Press **Stop/Reset** Pad to cancel the previous program and program again.

The program has not been entered correctly.

Program again according to the Operating Instructions.

Stop/Reset Pad has been pressed accidentally.

Program oven again.

"**LO**" appears in the **Display Window**.

The Child Lock was activated by pressing **Start** Pad 3 times.

Deactivate Lock by pressing **Stop/Reset** Pad 3 times.

"H97", "H98" or "H00" appears in the display window.

The display indicates a problem with microwave generation system.

Contact the specified service centre.

If it seems there is a problem with the oven, contact an authorized Service Centre.

Care of your Microwave Oven

Turn the oven off and remove the power plug from the wall socket before cleaning.

The outside oven surfaces should be cleaned with a damp cloth. To prevent damage to the operating parts inside the oven, water should not be allowed to seep into the ventilation openings.

Always clean the flat table after cooling down with a mild detergent and wipe to dry.

Keep the inside of the oven clean. When food splatters or spilled liquids adhere to oven walls, wipe with a damp cloth. Mild detergent may be used if the oven gets very dirty. The use of harsh detergent or abrasives is not recommended.

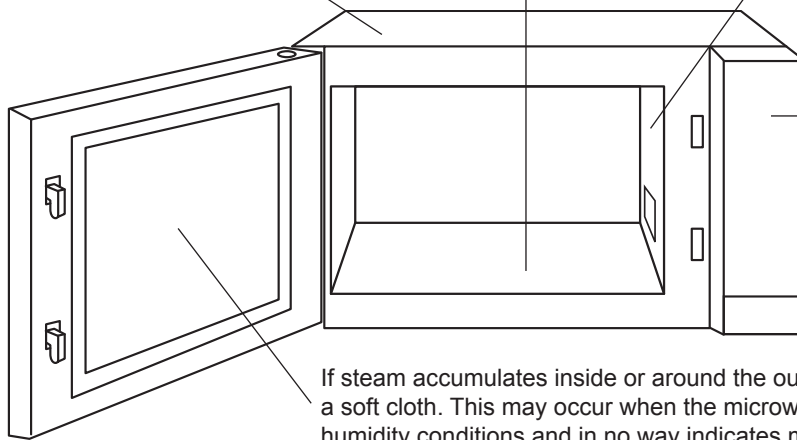

Do not allow the Control Panel to become wet. Clean with a soft, damp cloth. Do not use detergents, abrasives or spray on cleaners on the Control Panel. After cleaning touch Stop/Reset key to clear display window.

If steam accumulates inside or around the outside of the oven door, wipe with a soft cloth. This may occur when the microwave oven is operated under high humidity conditions and in no way indicates malfunction of the unit.

Do not use harsh abrasive cleaners or sharp metal scrapers to clean the oven door glass since they can scratch the surface, which may result in shattering of the glass.

NOTE:

Failure to maintain the oven in a clean condition could lead to deterioration of the surface that could adversely affect the life of the appliance and possibly result in a hazardous situation.

Technical Specifications

Power Supply:	230 ~ 240 V, 50 Hz	
Power Consumption*:	3.7 A 850 W	
Output*:	1,000 W	
Outside Dimensions (W x H x D):	529 mm (W) x 326 mm (H) x 422 mm (D)	
Oven Cavity Dimensions (W x H x D):	354 mm (W) x 230 mm (H) x 338 mm (D)	
Overall Cavity Volume:	27 L	
Operating Frequency:	2,450 MHz	
Uncrated Weight:	NN-SF574S	NN-SF564W
	Approx. 11.7 kg	Approx. 11.8 kg

Trim Kit (Australia and New Zealand only)

Model Name	NN-SF574S	NN-SF564W
Model Number	NN-TK510FSQP	NN-TK510FWQP
Outside Dimensions	596 mm (W) x 410 mm (H)	
Cabinet Opening	562 mm (W) x 395 mm (H) x 480 mm (D)	

* IEC Test Procedure

Specifications subject to change without notice.

As for the voltage requirement, the production month, country and serial number, please refer to the identification plate on the microwave oven.

Panasonic Warranty (For Australia)

Home Appliance 12 Month Warranty from Date of Purchase

1. Subject to the conditions of this warranty Panasonic or its Authorised Service Centre will perform necessary service on the product without charge for parts or labour, if in the opinion of Panasonic, the product is found to be faulty within the warranty period. For Communications products (i.e. Cordless Phones, etc) the genuine battery(s) has a 3 month warranty.
2. This warranty only applies to Panasonic products purchased in Australia and sold by Panasonic Australia or its Authorised Distributors or Dealers and only where the products are used and serviced within Australia or its territories. Warranty cover only applies to service carried out by a Panasonic Authorised Service Centre and only if valid proof of purchase is presented when warranty service is requested.
3. This warranty only applies if the product has been installed and used in accordance with the manufacturer's recommendations (as noted in the operating instructions) under normal use and reasonable care (in the opinion of Panasonic). The warranty covers normal domestic use only (also Clip & Trim Professional use) and does not cover damage, malfunction or failure resulting from use of incorrect voltages, incorrect installation, accident, misuse, neglect, build-up of dirt or dust, abuse, maladjustment of customer controls, mains supply problems, thunderstorm activity, infestation by insects or vermin, tampering or repair by unauthorised persons (including unauthorised alterations), exposure to abnormally corrosive conditions or any foreign object or matter having entered the product.
4. This warranty does not cover the following items unless the fault or defect existed at the time of purchase:
 - (a) Cabinet Parts
 - (b) Microwave Oven Plates.
 - (c) User replaceable Batteries
 - (d) Kneader Mounting Shaft, Shaver Heads, Cutters, Foils, Blades
 - (e) Accessories
 - (f) Noise or vibration that is considered normal
5. To claim warranty service, when required, you should:
 - Contact Panasonic's Customer Care Centre on 132600
 - Send or take the product to a Panasonic Authorised Service Centre together with your purchase receipt as a proof of purchase date. Please note that freight and insurance to and / or from your nearest Authorised Service Centre must be arranged by you.
6. The warranties hereby conferred do not extend to, and exclude, any costs associated with the installation, de-installation or re-installation of a product, including costs related to the mounting, de-mounting or remounting of any screen, (and any other ancillary activities), delivery, handling, freighting, transportation or insurance of the product or any part thereof or replacement of and do not extend to, and exclude, any damage or loss occurring by reason of, during, associated with, or related to such installation, de-installation, re-installation or transit.

Panasonic Authorised Service Centres are located in major metropolitan areas and most regional centres of Australia, however, coverage will vary dependant on product. For advice on exact Authorised Service Centre locations for your product, please telephone our Customer Care Centre on 132600.

In addition to your rights under this warranty, Panasonic products come with consumer guarantees that cannot be excluded under the Australian Consumer Law. If there is a major failure with the product, you can reject the product and elect to have a refund or to have the product replaced or if you wish you may elect to keep the goods and be compensated for the drop in value of the goods. You are also entitled to have the product repaired or replaced if the product fails to be of acceptable quality and the failure does not amount to a major failure.

If there is a major failure in regard to the product which cannot be remedied then you must notify us within a reasonable period by contacting the Panasonic Customer Care Centre. If the failure in the product is not a major failure then Panasonic may choose to repair or replace the product and will do so in a reasonable period of time from receiving notice from you.

**THIS WARRANTY CARD AND THE PURCHASE DOCKET (OR SIMILAR PROOF OF PURCHASE)
SHOULD BE RETAINED BY THE CUSTOMER AT ALL TIMES**

If you require assistance regarding warranty conditions or any other enquiries, please visit the **Panasonic Australia** website www.panasonic.com.au or contact by phone on **132 600**
If phoning in, please ensure you have your operating instructions available.

Panasonic Australia Pty. Limited

ACN 001 592 187 ABN 83 001 592 187

1 Innovation Road, Macquarie Park NSW 2113
www.panasonic.com.au

PRO-031-F01 Issue: 6.0

02-10-2013

Panasonic Warranty (For New Zealand)

Home Appliance 12 Month Warranty from Date of Purchase

1. Subject to the conditions of this warranty Panasonic or its Authorised Service Centre will perform necessary service on the product without charge for parts or labour, if in the opinion of Panasonic, the product is found to be faulty within the warranty period. For Line Communications products (i.e. Cordless Phones, etc) the genuine battery(s) has a 3 month warranty.
2. This warranty only applies to Panasonic products purchased in New Zealand and sold by Panasonic New Zealand or its Authorised Distributors or Dealers and only where the products are used and serviced within New Zealand or its territories. Warranty cover only applies to service carried out by a Panasonic Authorised Service Centre and only if valid proof of purchase is presented when warranty service is requested.
3. This warranty only applies if the product has been installed and used in accordance with the manufacturer's recommendations (as noted in the operating instructions) under normal use and reasonable care (in the opinion of Panasonic). The warranty covers normal domestic use only (also Clip & Trim Professional use) and does not cover damage, malfunction or failure resulting from use of incorrect voltages, incorrect installation, accident, misuse, neglect, build-up of dirt or dust, abuse, maladjustment of customer controls, mains supply problems, thunderstorm activity, infestation by insects or vermin, tampering or repair by unauthorised persons (including unauthorised alterations), exposure to abnormally corrosive conditions or any foreign object or matter having entered the product.
4. This warranty does not cover the following items unless the fault or defect existed at the time of purchase:
 - (a) Cabinet Parts
 - (b) Microwave Oven cook plates.
 - (c) User replaceable Batteries
 - (d) Kneader mounting shaft unit and Heads, Cutters, Foils, Blades and other accessories.
 - (e) Noise or vibration that is considered normal
5. To claim warranty service, when required, you should:
 - Telephone Panasonic's Customer Care Centre on 09 2720178 or visit our website referred to below and use the Service Centre Locator for the name/address of the nearest Authorised Service Centre.
 - Send or take the product to a Panasonic Authorised Service Centre together with your proof of purchase receipt as a proof of purchase date. Please note that freight and insurance to and / or from your nearest Authorised Service Centre must be arranged by you.
6. The warranties hereby conferred do not extend to, and exclude, any costs associated with the installation, de-installation or re-installation of a product, including costs related to the mounting, de-mounting or remounting of any screen, (and any other ancillary activities), delivery, handling, freighting, transportation or insurance of the product or any part thereof or replacement of and do not extend to, and exclude, any damage or loss occurring by reason of, during, associated with, or related to such installation, de-installation, re-installation or transit.

Panasonic Authorised Service Centres are located in major metropolitan areas and most regional centres of New Zealand, however, coverage will vary dependant on product. For advice on exact Authorised Service Centre locations for your product, please telephone our Customer Care Centre on 09 2720178 or visit our website and use the Service Centre Locator.

Unless otherwise specified to the consumer the benefits conferred by this express warranty are additional to all other conditions, warranties, guarantees, rights and remedies expressed or implied by the Consumer Guarantees Act of New Zealand and all other obligations and liabilities on the part of the manufacturer or supplier and nothing contained herein shall restrict or modify such rights, remedies, obligations and liabilities.

THIS WARRANTY CARD AND THE PURCHASE DOCKET (OR SIMILAR PROOF OF PURCHASE) SHOULD BE RETAINED BY THE CUSTOMER AT ALL TIMES

If you require assistance regarding warranty conditions or any other enquiries, please visit the **Panasonic New Zealand** website www.panasonic.co.nz or contact by phone on **09 2720178**
If phoning in, please ensure you have your operating instructions available.

Panasonic New Zealand Customer Care Centre

Phone: 09 2720178

Fax: 09 2720129

Email: customerservice@nz.panasonic.com

Website: www.panasonic.co.nz/support

Microwaves penetrate the surface of the food to a depth of about two to three centimetres and then the heat is gradually conducted in a random pattern. Some parts of food matter cook faster than others. Special microwave techniques are used to promote

fast and even cooking. Some of these techniques are similar to those used in conventional cooking, but because microwaves produce heat very quickly the following techniques are extremely important. It's a must for you to be familiar with the following tips.

Food Characteristics

Size and Quantity

Small portions cook faster than large portions. As you increase the quantity of food you put into the microwave oven, you must also increase your cooking time. The microwave oven has the same power regardless of quantity; thus the power is divided between more items and so it takes longer to cook. As a general guide, if you double the quantity of food suggested in the recipe, add half the time suggested again.

Liquid Content

Low moisture foods take a shorter time to cook than foods with a lot of moisture.

Shape

Uniform sizes cook more evenly. To compensate for irregular shapes, place thin pieces towards the centre of the dish and thicker pieces towards the outer edge of the dish.

Bone and Fat

Bones conduct heat and cause the meat next to them to be heated more quickly. Large amounts of fat absorb microwave energy and the meat next to these areas may overcook.

Starting Temperature

Food which has been sitting at room temperature takes less time to cook than refrigerated or frozen food.

Density and Composition

Porous, airy foods (cakes and breads) take less time to cook than heavy compacted foods (meat and vegetables). Recipes high in fat and sugar content cook more quickly.

Key to Symbols Used in Recipes

Recipes displaying these symbols may be cooked using these features.

A Auto Menu

Techniques for Preparation

Timing

A range of cooking times is given in each recipe for two reasons. First, to allow for the uncontrollable differences in food shapes, starting temperatures and personal preferences. Secondly, these allow for the differences in electrical voltage input which changes during peak load periods. Always remember that it is easier to add time to undercooked food. Once the food is overcooked, nothing can be done. For each recipe, an approximate cooking time is given.

Stirring

Stirring is often necessary during microwave cooking. We have noted when stirring is helpful in the recipes. Always bring the outside edges towards the centre and the centre portions to the outside.

Rearranging or Turning

Some foods should be turned in the container during cooking. For example, because of the different thicknesses in the breast and back sections of poultry, it is a good idea to turn poultry over once to ensure more even cooking. Rearranging or turning over uneven shaped food in the dish should be done as suggested to ensure a satisfactory result. Rearrange small items such as chicken pieces, prawns, hamburger patties, nuts or potatoes. Rearrange pieces from the centre to the edge of the dish.

Cooking in Layers

This microwave oven is not designed to cook more than 1 layer of food. Cooking in 2 layers may not always be successful, it takes longer and may be uneven. You can successfully reheat two dinner plates of food at one time but remember to increase the reheating time and use a microwave warming rack.

Piercing of Foods

Pierce the skin or membrane of foods such as eggs, tomatoes and jacket potatoes when cooked whole in the microwave oven. This allows steam to escape. If the skin has not been pierced, food may burst.

Cured Meats

Cured meats may overcook in some areas due to the high concentration of salts used in the curing process. So take care when cooking different brands of bacon as cooking times may vary slightly.

Soups

Use a bowl and stir before heating and at least once through reheat time and again at the end.

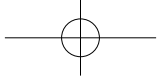

Techniques for Preparation

Covering

Covering food minimizes the microwave cooking time.

Because microwave cooking is done with time and not direct heat, the rate of evaporation cannot be easily controlled. However, this can be corrected by using different materials to cover dishes. Plastic wrap is the best substitute for a lid as it creates a tighter seal and so it retains more heat and steam. Wax paper and paper towels hold the heat in but not the steam. These materials also prevent splattering. Use a paper towel, wax paper or no cover when steam is not needed for tenderising.

Browning

Meats and poultry, when cooked longer than 10 to 15 minutes, will brown from their own fat. Foods cooked for shorter periods of time can be aided with the help of a browning sauce, worcestershire sauce or soy sauce. Simply brush one of these sauces over meat or poultry before cooking. Baked goods do not need long cooking time and therefore, do not brown. When cakes or cupcakes are iced, no one will notice the visual difference. For cakes or cupcakes, brown sugar can be used in the recipe in place of caster sugar or the surface can be sprinkled with dark spices before baking.

Standing Time

The moisture molecules continue to vibrate in the food when the microwave oven has turned itself off. After all, the molecules were vibrating at 2,450,000,000 times per second during cooking. So cooking continues even after the food is no longer being exposed to the microwaves whether in or outside your microwave oven.

Standing time refers to the time it takes (after the microwave time is completed) to allow the interior of the food to finish cooking.

The amount of standing time varies with the size and density of the food. In meat cookery, the internal temperature will rise between 5 °C and 10 °C if allowed to stand covered for ten to fifteen minutes. Rice and vegetables need shorter standing time, but this time is necessary to allow foods to complete cooking in the centre without overcooking on the edges.

The power level used in microwave cooking also determines the standing time. For example, when using a lower power level the standing time is shorter because of a lower concentration of heat in the food. Foods should always be kept covered while standing in order to retain the heat. If a longer standing time is required (while you cook another food to serve with the first, for instance), cover with aluminum foil.

Converting Your Favourite Conventional Recipes for Microwave Cooking

When adapting conventional recipes for microwave cooking, time are reduced considerably.

For example, a chicken which takes 1 hour to cook in a moderate oven will take 15 to 20 minutes on Med-High Power in your microwave oven.

Use similar microwave recipes to help you adapt conventional recipes. Remember, it is always best to undercook a recipe and then add an extra minute or two to finish it off.

Here are some other tips that may help:

- Reduce liquids in a conventional recipe by one half to two thirds, e.g. 1 cup (250 ml) should be reduced to ½ cup (125 ml).
- Add more thickening such as flour or cornflour to sauces and gravies if you do not reduce the liquid.
- Reduce seasonings slightly in a recipe where ingredients do not have time to simmer by microwave.
- Do not salt meats, poultry or vegetables before cooking; otherwise, they will toughen and dry out.
- If one ingredient takes longer to cook than the others, pre-cook it in the microwave oven first. Onion, celery and potato are examples.
- When cooking meat or vegetables, omit any oil or fat that would have been used in a conventional recipe for browning.
- Reduce leavening agents for cakes by one quarter and increase liquids by one quarter.
- Biscuits require a stiff dough. Increase flour by about 20 percent. Substitute brown sugar for white sugar and use biscuit recipes that have dark spices or require icing. Because of the short cooking time, biscuits don't have time to brown. Chill dough for half an hour before baking. This produces a crisper biscuit. Bake biscuits on a glass tray lined with greaseproof paper.
- Since microwaves penetrate foods about two centimetres from the top, bottom and sides, mixtures in round shapes and rings cook more evenly. Corners receive more energy and may overcook.
- Items with a lot of water, such as rice and pasta, cook in about the same time as they would on a conventional stove. (Refer to **Rice** and **Pasta** chapter.)

Select recipes that convert easily to microwave cooking such as casseroles, stews, baked chicken, fish and vegetable dishes. The results from foods such as grilled meats, cooked souffles or two-crust pies could be less than satisfactory. Never attempt to deep fry in your microwave oven.

Menu Planning for Microwave Cooking

How to Keep Everything Hot at The Same Time

Plan your meals so that the food will not all need last minute cooking or attention at the same time. The special features of microwave cookery make it easy to serve meals with everything piping hot. Cooking of some foods may be interrupted while you start others, without harming the nutritional value or flavour of either.

A recipe which requires standing time can be microwaved first and another food cooked while it stands. Dishes prepared in advance can be reheated briefly before serving.

It does take some experience and time to cook with confidence. Microwaves are fast so you will have to do some experimenting. You might find you will use your conventional range in conjunction with your microwave oven. For example, while cooking the roast in the microwave oven, you can be cooking the vegetables and gravy on the range top. This can also be done the other way around. Prepare your meals as follows.

1. Firstly, cook the most dense item (roast or casserole). Drain and retain meat juice from joints then cover with foil.
2. Cook the potatoes, rice or pasta.
3. Cover with foil for standing.
4. Cook greens and other vegetables.
5. Cover with foil for standing.
6. Cook the gravy with the retained meat juices, stock and thickening.
7. Carve the roast and serve the vegetables and gravy.

While you are learning to plan meals, you may get a bit behind time. Don't worry. Dinner servings may be suitably reheated on Med-High, for 1 to 2 minutes per serving.

If you prefer not to use foil, cover food with saucepan lids. A metal lid will retain the heat for at least 15 minutes.

Meanwhile, how can you cook all the vegetables at the same time? Simply place potatoes and pumpkin in one dish and less dense vegetables such as broccoli, cabbage, cauliflower, beans and peas in another. Sprinkle greens with water. Cover with a lid or plastic wrap. Cook on High for cooking times refer to vegetable cooking chart on page 44-45. Fresh and frozen vegetables can be mixed on a vegetable platter, but remember frozen vegetables are not as dense as fresh vegetables, as they have been blanched before freezing.

If vegetables are cut to a similar size, they can be cooked in separate ramekins or small dishes at the same time.

Increasing & Decreasing Recipes

Increasing

- To increase a recipe from 4 to 6 servings, increase each ingredient listed by half.
- To increase a recipe from 4 to 8 servings, double each ingredient listed.
- For larger quantities of a recipe, a large dish should be used. Make sure that the dish is deep enough to prevent the recipe from boiling over during cooking.
- Make sure to cover, stir or rearrange food as directed in the recipe and always check the food during cooking.
- Increase standing times by 5 minutes per 500 g.
- Use the same Power Level recommended in the original recipe.
- Increase the cooking times by: $\frac{1}{3}$ of original cooking time for 6 servings; and an extra $\frac{1}{2}$ of original cooking time for 8 servings.

Decreasing

- To decrease a recipe from 4 to 2 servings, decrease each ingredient listed by half.
- For small quantities, a small dish should be used. Make sure that the dish is large enough to prevent the recipe from boiling over during cooking.
- Use the same Power Level recommended in the original recipe.
- Decrease the cooking times by $\frac{1}{2}$ to $\frac{2}{3}$ of the original cooking time.

Cooking for One

- To decrease a recipe from 4 to 1 serving, quarter each ingredient listed.
- A smaller dish should be used, making sure that the dish is still large enough to prevent the recipe from boiling over.
- Use the same Power Level recommended in the original recipe.
- Quarter the original cooking times, then add extra time, if needed.
- Make sure to cover, stir or rearrange food as directed in original recipe and always check the food during cooking.

Converting Recipes from Other Sources

When the recipe is written with a wattage different than your oven, adjust the cooking time by approximately 10% per 100 watts, e.g. 6 minutes would be adjusted by 36 seconds. Alternately, adjust the power level by one level. If your wattage is higher than the recipe: (1) Adjust time downward or (2) Adjust power level downward. If your wattage is lower than the recipe: (1) adjust time upward or (2) adjust power level upward (when possible).

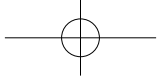

Reheating

One of the most common uses for a microwave oven is to reheat food. Your Panasonic microwave allows you to either reheat by placing food into the oven and you choose the micro power level and length of heating time or you may reheat automatically by using the AUTO REHEAT Pads on your microwave. Following are some directions for reheating pre-cooked foods from either frozen refrigerator temperature or room temperature.

General rules for reheating foods by Micro Power

- Many convenience foods contain heating instructions on the packaging. It is best to follow these instructions, being sure to check the wattage of the oven they used and adjust the cooking time if necessary (decrease cooking time by 10% for every 100watts more powerful your oven is).
- If package directions are not available, follow the recommendations in the charts on the following pages.
- All foods must be pre-cooked; raw foods will not cook through during reheating times and if consumed may cause illness.
- Do not reheat in foil containers, cans or plastic containers as incorrect heating times will result. Place foods into microwave safe bowls or onto dinner-plates before heating.
- Most foods can be heated on High but consider if the food is delicate in structure like baked custard or you have a large quantity, a lower power level for slightly longer may be gentler.
- Cover foods with plastic wrap if you require a steamed effect or leave uncovered for a drier surface, e.g. Crumbed foods.

Note: when cooking by Sensor Cook all food must be covered.

- Stir or re-arrange foods during heating as this will help food heat evenly. Stir after heating and let stand for 2 to 3 minutes. Check temperatures before adding extra heating time and ensure food is hot. If food is not heated enough, consumption may cause illness.

Caution:

Pastry items which have a filling that is high in fat, sugar or moisture will become hotter in the centre and the pastry may only feel warm. Ensure you allow it to stand for several minutes before eating.

IMPORTANT POINTS TO CONSIDER WHEN REHEATING COLD FOODS

STARTING TEMPERATURE — Foods taken from the refrigerator will take longer to reheat than foods from room temperature.

Quantity — One serving heats faster than several servings. When heating large quantities, stir food to ensure even heating. It is quicker to heat individual plates of food than large quantities in a casserole dish.

Plated Dinners — Arrange foods with the most dense items towards the outside of the plate. Cover meats with sauces/gravies if desired, spread out mashed potatoes or rice so it heats more evenly. When assembling plates of leftover foods, use foods which have a similar starting temperature.

Covering Foods — Most foods need to be covered with one sheet of absorbent paper towel to hold in the heat and prevent splattering without steaming. When more moisture is desired, cover with plastic wrap.

Heating — Reheating is usually done on High, however, if food has a more delicate texture, like a baked custard, a lower power setting should be used. Med-High for a little longer will be gentler on the food. An average plate of food would generally take 1 to 3 minutes to heat depending on the density of the food. Place it in for the minimum time and add extra heating time if required. Ensure food is hot by feeling the bottom of the plate in the centre. If the plate is cool, food may be warm but will lose heat quickly as the plate will absorb the heat and taste cold when served. If food is not heated enough, consumption may cause illness.

Elevation — Elevate pastries and breads on a small plastic rack with paper towel under the food to prevent it from becoming soggy.

IMPORTANT POINTS TO CONSIDER WHEN REHEATING FOODS FROM THE FREEZER

VOLUME — The greater the volume and the more dense the item, the longer it takes to reheat. E.g. frozen cake will take less time than frozen casserole.

LARGE VOLUME — Large, dense, frozen precooked foods are best thawed on defrost until icy in the centre then heated on Med-High. This prevents overcooking of the edges. Stirring is often needed to distribute heat evenly.

Commercial frozen foods — These foods should be removed from their foil containers if possible and placed into suitable microwave safe containers. If a foil container is used in the microwave oven it shouldn't be more than 4 cm high and must not touch the interior of the microwave oven. Remove the cover from the tray and replace with paper towel or plastic wrap to prevent splattering.

Foods to be served at room temperature — For best results, defrost for a short time and allow to stand to complete thawing, e.g. frozen cake.

Vacuum sealed pouches — Pierce pouches, bags before heating to allow steam to escape. This prevents bursting.

Containers — Use dishes about the same volume of the food or slightly larger to allow for stirring. Remove or release snap seal lids otherwise they will pop during heating and may disfigure.

Pies and pastries — Pies and pastries that contain raw pastry and filling cannot be cooked in the microwave oven. Precooked products can be thawed and heated. Place them on a sheet of paper towel and elevate on plastic rack for best results. For added crispness place under the grill or in a hot oven for few minutes. Pastry items can become tough and rubbery if overheated, remember to allow 5 minutes standing then test before adding extra heating time.

Reheating by Micro Power - Frozen Pre-cooked Foods

FROZEN ITEM (Pre-cooked)	POWER	TIME (in minutes)	SPECIAL INSTRUCTIONS
BREAD & BAKED PRODUCT			
Bread 1 slice	Medium	15 - 20 sec	Do not let bread get hot, or it will become rubbery and dry out. Remove whole loaf from original wrapper. Place on paper towel to absorb moisture.
1 loaf	Medium	2 - 3	
6 rolls	Medium	½ - 1	
Cheesecake (450 g)	Defrost	5 - 7	Remove from container. Defrost on plate.
Muffins - 4 (400 g)	Med-High	1 - 1½	Place onto paper towel lined plate.
Scones - 6 (400 g)	Medium	1½ - 2	Defrost on paper lined plate. Stand 2 minutes.
PIES			
Fruit Pie (600 g)	Defrost then Med-High	5 - 7 5 - 7	Remove from foil container and place uncovered into a pie dish.
Meat Pie (175 g)	Med-High	4 - 5	Place onto paper towel lined plate.
Pizza (350 g)	High	3 - 4	Remove from package and place onto paper towel or follow manufacturer's instructions.
FROZEN MEAL			
Fish in Sauce (200 g)	Medium	5 - 6	Pierce corner of bag. Heat on a plate.
Frozen Casserole (500 g)	High	6 - 8	Pierce pouch. Heat on a plate or bowl.
Lasagne (500 g)	High	8 - 10	Remove from foil container, place into serving dish.
Plated style dinner (320 g)	Medium	7 - 9	Remove foil cover and replace with plastic wrap.
Vegetables & Sauce (in the bag) (500 g)	Med-High	4 - 6	Pierce corner of bag. Heat on a plate.
MISCELLANEOUS			
Chicken Pieces (500 g)	Med-High	8 - 10	Place onto paper towel lined plate.
Chicken Nuggets (12)	Med-High	3 - 4	
Croissants - 4 (200 g)	Defrost	1 - 1½	Place onto paper towel lined plate.
Fish Fingers - 8 (200 g)	Defrost then High	2 - 4 2 - 3	Place onto paper towel lined plate.
Sausage Rolls (225 g)	Medium	4 - 5	Place onto paper towel lined plate.

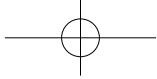

PUMPKIN SOUP

Serves: 4

Ingredients:

500 g	pumpkin, peeled and chopped
½	onion, diced
1 cup	chicken stock
½ teaspoon	curry powder
	pepper

Method:

Place pumpkin, onion and curry powder in a 2-litre casserole dish. Cover and cook on High for 7 minutes. Add chicken stock and pepper. Cook on High for 7 minutes. Cool slightly. Purée pumpkin and liquid in blender or food processor. Pour into individual serving dishes and garnish with chives.

SHORT AND LONG SOUP

Serves: 4

Ingredients:

200 g	fresh singapore noodles
12 (200 g)	frozen mini dim sims
4	green onions, sliced
1 litre	chicken stock
1 teaspoon	crushed garlic
½ teaspoon	chopped ginger
2 tablespoons	soy sauce
1	chicken breast, cooked and sliced
4	baby bok choy, quartered
1 cup	bean sprouts
2 tablespoons	dried onion (optional)

Method:

Place all ingredients except bok choy and bean sprouts in a 4 litre casserole dish and cook on High for 10 minutes. Add bok choy and cook on High for 2 minutes. Serve in individual bowls topped with bean sprouts and onion.

HINT:

To cook 1 double chicken breast. Place onto a dinner plate. Cover and cook on Med-High for 8 to 10 minutes.

HINT:

To reheat a single portion of soup. Place in a microwave safe dish and cook on Med-High for 2 to 3 minutes.

PEA AND HAM SOUP

Serves: 6

Ingredients:

2½ cups	green split peas
850 g	smoked ham hock
1	medium onion, chopped
1 tablespoon	fresh thyme leaves
1	bay leaf
6 cups	chicken stock
½ cup	frozen peas

Method:

Wash split peas and place in a 2-litre capacity bowl with 1-litre of water. Cover and allow soaking for 8 hours or overnight. Remove rind from ham hock and discard. Cut meat away from the bone and roughly chop. Reserve bone. Drain peas and place into a 5-litre capacity microwave safe dish. Add ham bone, chopped ham, onion, thyme, bay leaf and chicken stock. Cook uncovered on High for 15 minutes. Reduce power to Medium and cook for 15 minutes. Skim top of soup and cook on Medium for a further 30 minutes. Remove ham bone and bay leaf and stir in frozen peas. Cook on Medium for 10 minutes. Blend half the soup and return to the bowl, stirring through the remaining soup. Serve hot with crusty bread.

Tip:

Substitute 500 g bacon bones and 250 g of diced bacon rashers for the ham hock. Do not add salt when cooking lentils or pulses, as they will toughen. Add salt after cooking if desired.

POTATO AND LEEK SOUP A

Serves: 4 to 6

Ingredients:

500 g	potatoes, peeled and diced
1	medium thinly sliced leeks
1 teaspoon	fresh thyme
	pepper
1 cup	chicken stock
75 ml	cream

Method:

Place potatoes, leeks, thyme and pepper in 3-litre casserole dish. Cover and cook on High for 8 minutes. Stir in chicken stock. Cover and cook on High for 16 to 18 minutes. Purée soup mixture. Stir in cream and serve hot or cold in individual bowls.

To Cook by Auto Cook:

Prepare as above. Select **Root Vegetables**, press

▲ Weight ▼ to select weight 500 g, then press **Start**.

CHICKEN AND PRAWN LAKSA

Serves: 4

Ingredients:**Soup:**

2 tablespoons laksa paste
 400 ml coconut milk
 1 litre chicken stock
 1 tablespoon soy sauce
 fresh ground black pepper

Laksa:

250 g rice noodles
 8 cups boiling water
 1 bunch coriander, leaves chopped
 4 small red chillies, seeds removed and finely chopped
 ½ cup bean sprouts
 4 lime wedges
 1 tablespoon peanut oil
 400 g cooked chicken tenderloins, sliced
 12 green king prawns, peeled

Method:**Soup:**

Place the laksa paste, coconut milk, stock, soy sauce and pepper into a 3-litre dish and cook covered on High for 8 to 10 minutes.

Laksa:

Place the noodles and water in a 4 litre dish. Cover and cook on High for 2 to 3 minutes, stirring halfway through. Drain well and divide between 4 deep bowls. Place the coriander, chillies, bean sprouts and lime on top. Place the peanut oil and prawns in a 1-litre dish and cook on Med-High for 3 to 5 minutes, stirring halfway through. Add the chicken and prawns to each individual bowl and set aside.

To serve:

Heat soup on High for 2 minutes. Pour the hot soup over the ingredients in the 4 bowls and serve.

NUTS AND BOLTS

Serves: 6 to 8

Ingredients:

80 g butter
 2 teaspoons curry powder
 2 tablespoons worcestershire sauce
 ½ teaspoon salt
 ¼ teaspoon garlic powder
 100 g packet mixed rice crackers
 100 g fried noodles
 200 g salted peanuts
 125 g packet pretzel sticks
 ½ cup Nutri-Grain

Method:

Place butter, curry, worcestershire sauce, salt and garlic powder in a 3-litre casserole dish. Cook on High for 1 to 2 minutes. Add remaining ingredients, mix well and cook on High for 4 to 5 minutes. Stir twice through cooking. Allow to cool. Place in a bowl and serve with drinks. Store in an airtight container once cool.

NACHOS SUPREME

Serves: 4 to 6

Ingredients:

500 g topside mince
 35 g Taco seasoning mix
 ⅓ cup tomato paste
 1 teaspoon Mexican chilli powder
 310 g can red kidney beans, mashed in liquid
 180 g corn chips
 1 avocado
 ½ cup sour cream
 ½ cup grated cheese
 paprika

Method:

Place meat in a 2-litre dish. Cook on Med-High for 6 minutes, stirring halfway through. Mix with fork, breaking up any large pieces of meat. Add taco mix, tomato paste, chilli powder and kidney beans. Cook on Med-High for further 10 minutes, stirring halfway through cooking. Place corn chips in a 3-litre microwave suitable serving dish. Pile meat sauce in the centre. In a small bowl, mash avocado and mix in sour cream. Spoon this mixture over meat sauce and top with grated cheese. Sprinkle with paprika. Heat on Med-High for 3 to 4 minutes.

ZUCCHINI SLICE

Serves: 4 to 6

Ingredients:

4 rashers bacon, diced
 1 onion, diced
 2 cups grated zucchini
 2 cups grated carrot
 1 cup grated tasty cheese
 1 cup self raising flour
 5 eggs, lightly beaten
 125 ml vegetable oil
 1 tablespoon fresh chopped parsley
 salt and pepper

Method:

Lightly grease a 25 cm square microwave safe dish. Place bacon and onion in a 2-litre casserole dish and cook on High for 2 to 3 minutes. Allow to cool slightly. Stir in zucchini, carrot and cheese and flour. In a 1-litre bowl whisk together eggs, oil and parsley. Add to bacon mixture season with salt and pepper and stir until combined. Pour into prepared dish. Cook on Medium for 17 to 19 minutes.

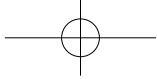

Cooking Fish and Shellfish by Micro Power

Clean fish before starting the recipe. Arrange fish in a single layer, overlap thin fillet ends to prevent overcooking. Prawns and scallops should be placed in a single layer.

Cover dish with plastic wrap. Cook on the power level and for the minimum time recommended in the chart below. Halfway through cooking rearrange or stir prawns, fish fillets or scallops.

Cooking Fish and Shellfish by Micro Power

FISH OR SHELLFISH	AMOUNT	POWER	APPROX. COOKING TIME (in minutes)
Fish Fillets	500 g	Med-Low	8 to 10
Scallops (sea)	500 g	Med-Low	6 to 8
Green Prawns medium size (shelled and cleaned)	500 g	Med-Low	7 to 9
Whole Fish (stuffed or unstuffed)	500 g to 600 g	Med-Low	9 to 11

SALMON MORNAY

Serves: 4

Ingredients:

40 g butter
 1 onion, diced
 ¼ cup flour
 1 tablespoon chopped fresh parsley
 pepper
 ½ teaspoon prepared mustard
 1½ cups milk
 440 g can salmon and liquid
 ½ cup fresh bread crumbs
 ⅓ cup grated cheese

Method:

Place butter and onion in a 4-cup jug. Cook on High for 1 minute. Add flour and cook on High for 1 minute. Add parsley, pepper, mustard and gradually blend in milk. Cook on High for 2 to 3 minutes, stir halfway through cooking. Lightly mix through salmon and liquid into sauce. Pour into serving dish and top with bread crumbs and cheese. Cook for further 4 to 5 minutes on High power.

SALMON STEAKS WITH LIME BUTTER

Serves: 4

Ingredients:

60 g butter
 1 clove garlic, crushed
 1 teaspoon grated fresh ginger
 1 teaspoon grated lime rind
 2 tablespoons lime juice
 ½ teaspoon sugar
 500 g salmon, steaks

Method:

Place butter, garlic, ginger, lime rind, juice and sugar in a shallow dish. Cook on Med-High for 1 to 2 minutes. Stir halfway through cooking. Add salmon steaks and coat with sauce. Cover and cook on Medium for 5 to 7 minutes. Stand for 2 to 3 minutes before serving.

SPICED WHOLE BREAM

Serves: 2

Ingredients:

2 x 400 g whole bream
 1 clove garlic
 3 stalks coriander
 1 red birds eye chilli
 1 tablespoon freshly chopped ginger
 1 tablespoon lime juice
 2 teaspoons fish sauce
 2 teaspoons brown sugar
 2 green onions, sliced

Method:

Clean and scale fish, set aside. Process remaining ingredients in a food processor to form a paste. Rub the spice paste into the fish and place them in a microwave safe dish. Cook on P4 for 12 to 15 minutes.

MALAY COCONUT FISH

Serves: 4

Ingredients:

400 ml	coconut milk
1 tablespoon	chilli sauce
1	lime zested
5 cm	piece peeled ginger, finely chopped
1 tablespoon	garam masala
1 tablespoon	fish sauce
2 tablespoons	brown sugar
800 g	fish fillets, halved
¼ cup	fresh coriander leaves

Method:

Mix coconut milk, chilli sauce, lime rind, ginger, garam masala, fish sauce and brown sugar in a 2-litre dish. Cover and cook on High for 8 minutes, stir halfway through. Add fish, ensuring all surfaces are coated well. Cover and cook on Medium for 9 to 10 minutes, turning fish halfway through cooking. Allow standing for 5 minutes. Top with coriander leaves and serve with steamed rice.

LEMON PEPPER FISH A

Serves: 2

Ingredients:

400 g	fish fillets
¼ cup	lemon juice
1 teaspoon	cracked black pepper

Method:

Place fish, lemon juice and cracked black pepper in a 1-litre casserole dish. Cook on Medium for 5 to 7 minutes. Let stand for 3 minutes before serving.

To Cook by Auto Cook:

Prepare as above. Select **Steam Fish**, press

▲ Weight ▼ to select weight 400 g, then press

Start.**GARLIC PRAWNS**

Serves: 2

Ingredients:

60 g	butter
2 cloves	garlic, crushed
1 tablespoon	lemon juice
1 tablespoon	chopped parsley
500 g	peeled green prawns

Method:

Place butter and garlic in a 2-litre dish and cook on High for 30 to 50 seconds. Add lemon juice, parsley and prawns. Cook on Medium for 8 to 10 minutes, stirring halfway through cooking. Serve in individual ramekins.

GARLIC & CHILLI PRAWNS

Serves: 4

Ingredients:

1 kg	medium uncooked king prawns
1	small red onion, thinly sliced
40 g	butter
3	garlic cloves, crushed
2	fresh bird's eye chillies, deseeded & finely chopped
½	small red capsicum, finely sliced
100 g	snow peas, trimmed
1 tablespoon	lemon juice
80 ml	thickened cream
¼ cup	coriander leaves, chopped
	Cooked jasmine rice, to serve

Method:

Peel and de-vein prawns leaving tails in tact, set aside. Place onion, butter, garlic and chilli into a 3-litre microwave safe dish. Cook on High for 4 minutes, stir halfway through cooking. Add prawns and mix to combine. Cook on Med-High for 3 minutes. Stir in capsicum and snow peas, cover and cook on Med-High for a further 3 minutes. Stir through lemon juice, cream and coriander, season and cook on High for 1 minute. Serve immediately with cooked rice.

TOMATO BASIL MUSSELS

Serves: 4

Ingredients:

1 kg	fresh mussels
¼ cup	water
1 tablespoon	olive oil
1	leek, sliced
1	clove garlic, crushed
440 g	can tomato pieces
1 tablespoon	tomato paste
½ teaspoon	oregano
2 tablespoons	chopped fresh basil
	freshly ground black pepper

Method:

Place mussels and water into a bowl. Cover and cook on Med-High for 4 to 6 minutes. Set aside. Place oil, leeks and garlic into a 3-litre dish. Cook on High for 2 minutes. Stir well. Add tomatoes, tomato paste, oregano, basil and pepper. Mix well. Cook on High for 3 to 4 minutes. Add mussels. Cover and cook on High for 2 to 3 minutes. Serve immediately.

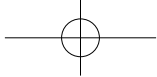

OYSTER SOUP

Serves: 4 to 6

Ingredients:

30 g	butter
2 tablespoons	flour
2 cups	chicken stock
½ cup	cream
20	bottled oysters, drained
	salt and white pepper
	snipped chives to garnish

Method:

Place butter in 2-litre casserole dish and cook on High for 1 minute. Add flour, stir well and cook on High for 30 seconds. Gradually add stock, stirring continuously. Cook on High for 5 to 7 minutes, stirring halfway through cooking. Add cream, oysters, salt and pepper. Cook on Med-High for 1 to 2 minutes. Spoon into individual dishes and garnish with chives.

OYSTERS KILPATRICK

Serves: 12

Ingredients:

2 rashers	bacon finely chopped
1 tablespoon	worcestershire sauce
2 teaspoons	lemon juice
1 tablespoon	barbecue sauce
12	oysters in shell

Method:

Spread bacon onto a dinner plate. Cover with paper towel and cook on High for 2 to 3 minutes. Mix together worcestershire sauce, lemon juice and barbecue sauce. Place oysters in shell evenly around dinner plate and sprinkle with bacon mixture. Pour some sauce mixture over each oyster. Cook on High for 1 to 1½ minutes.

SEAFOOD MARINARA

Serves: 4

Ingredients:

750 g	Marinara mix
2 tablespoons	butter
1	clove garlic, crushed
2	tomatoes, peeled and chopped
1 tablespoon	tomato paste
¼ cup	white wine
¼ cup	fresh basil leaves, chopped
	pepper

Method:

Place marinara mix into a 2-litre casserole dish. Set aside. Place butter and garlic in 1-litre casserole dish. Cook on Med-High for 1 minute. Add remaining ingredients (except seafood), to dish and cook on High for 5 minutes. Purée tomato mixture in blender or food processor and pour over seafood. Cook on Medium for 7 to 9 minutes, stir halfway through cooking. Stand for 5 minutes. Serve with salad and pasta.

BOUILLABAISSE

Serves: 4 to 6

Ingredients:

2 tablespoons	olive oil
2	onions, sliced
1	large leek, sliced
4 cloves	garlic, crushed
425 g	tomato pieces
½ cup	tomato paste
4 cups	hot fish stock
⅓ cup	dry white wine
1 tablespoon	fresh thyme leaves
½ teaspoon	saffron powder
1 teaspoon	chilli powder
	freshly ground black pepper
	salt
500 g	firm fish fillets, chopped
500 g	green prawn meat, de-veined

Method:

Place oil, onions, leek and garlic in a 4 litre dish. Cover and cook on High for 6 to 8 minutes. Stir halfway through cooking. Add tomatoes, tomato paste, fish stock, wine, thyme, saffron, and chilli powder. Season with salt and pepper. Cook on High for 12 minutes. Add fish fillets and prawns. Cook on High for 6 to 8 minutes or until seafood is cooked. Serve garnished with fresh thyme.

Noise

During cooking, popping sounds may be heard. This is due to moisture trapped between the flesh, particularly with oily fish such as salmon and mackerel. This can be minimised when cooking if the skin and flesh is pierced several times with a skewer.

Cooking Whole Poultry by Micro Power

Season as desired, but salt after cooking. Browning sauce mixed with equal parts of butter will enhance the appearance.

Poultry must be unstuffed. Tie legs together with cotton string. Place on a microwave rack set in a rectangular dish. Place poultry breast-side down: turn over halfway through cooking. Cover with wax paper to prevent splattering.

If the poultry is not cooked enough, return it to the oven and cook a few more minutes at the recommended power level.

DO NOT USE A CONVENTIONAL MEAT THERMOMETER IN THE MICROWAVE OVEN.

Let stand, covered with foil, 10 to 15 minutes after cooking. Standing time allows the temperature to equalize throughout the food and finishes the cooking process.

If a large amount of juice accumulates in the bottom of the baking dish, occasionally drain it. If desired, reserve juices for making gravy.

Less-tender birds should be cooked in liquid such as soup or broth. Use ¼ cup per 500g of poultry.

Use an oven cooking bag or a covered casserole. Select a covered casserole deep enough so that bird does not touch the lid.

If an oven cooking bag is used, prepare according to package directions. Do not use wire twist-ties to close bag. Use only nylon tie, a piece of cotton string, or a strip cut from the open end of the bag. Make six 2 cm slits on top of bag.

Multiply the weight of the poultry by the minimum recommended minutes per 500 g. See chart below. Programme Micro Power and Time.

After cooking, check the internal temperature of the bird with a microwave or conventional meat thermometer inserted into the muscle. Check temperature in both muscles. The thermometer should not touch bone. If it does, the reading could be inaccurate. A thermometer cannot be accurately inserted into a small bird. To check desired cooking of a small bird, juices should be clear and the drumsticks should readily move up and down after standing time.

During cooking, it may be necessary to shield legs, wings and the breast bone with foil to prevent overcooking. Wooden toothpicks can be used to hold foil in place.

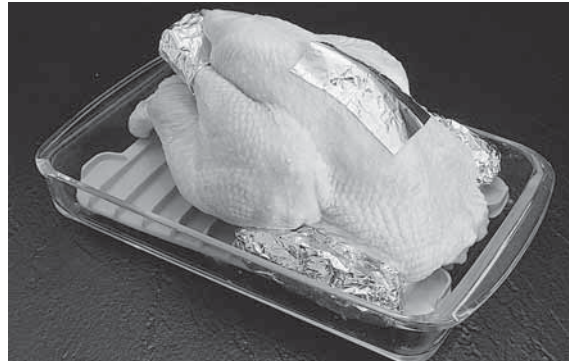

Cooking Poultry Pieces by Micro Power

Cover with wax paper or paper towel. Use the chart below to determine recommended minimum cooking times.

Arrange pieces skin-side down and evenly spread in a shallow dish.

Turn or rearrange halfway through cooking. Shield wing tips, drumstick ends etc., if required.



Cooking Poultry by Micro Power

POULTRY	POWER	TEMPERATURE AFTER COOKING	APPROX. COOKING TIME (minutes per 500 g)
Chickens (up to 2 kg)	Med-High	87 °C	9 to 12
Chicken (pieces)	Med-High	87 °C	7 to 9
Turkey (up to 2.5 kg)	Med-High	87 °C	10 to 15
Duck	Med-High	87 °C	8 to 13

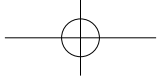

CHICKEN AND POTATO CASSEROLE

Serves: 4

Ingredients:

1	cooked BBQ chicken
500 g	potatoes, peeled and thinly sliced
1¼ cups	water
30 g	butter
1	onion, finely chopped
1	clove garlic, crushed
2 tablespoons	plain flour
1 cup	chicken stock
2 teaspoon	french mustard
½ cup	cream
¾ cup	grated tasty cheese
	paprika

Fresh coriander, Mango chutney and Pappadums to serve

Method:

Remove chicken meat from bones. Place potatoes and water in a 2-litre casserole dish. Cover and cook on High for 8 to 10 minutes. Drain. Combine chicken and potatoes. Set aside. Place butter in a 4-cup glass jug and cook on Med-High for 40 seconds. Add onion and garlic to jug and cook on High for 1 to 2 minutes. Add flour and stir. Gradually add stock and blend to a smooth paste. Cook on High for 2 to 3 minutes. Stir every minute.

Add mustard and cream. Stir well. Pour sauce over chicken and potato mixture. Sprinkle with cheese and paprika. Cook on Med-High for 4 to 6 minutes. Serve with vegetables.

HONEY SESAME DRUMSTICKS A

Serves: 4

Ingredients:

400 g	chicken drumsticks
½ teaspoon	chopped garlic
½ teaspoon	chopped ginger
¼ cup	soy sauce
¼ cup	honey
1 tablespoon	sesame seeds

Method:

Place all ingredients in a 2-litre bowl, stir until combined. Marinate for at least 2 hours or overnight. Remove chicken from marinade and place in shallow dish with the meatiest ends to the outside. Cook on Med-High for 8 to 10 minutes, turning once during cooking.

To Cook by Auto Cook:

Prepare as above. Select **Steam Chicken Pieces**,

press ▲ Weight ▼ to select weight 400 g, then press **Start**.

CHICKEN BURRITOS

Serves: 4

Ingredients:

1 clove	garlic, crushed
2	large onions, chopped
1 teaspoon	chilli powder (optional)
35 g	taco seasoning mix
500 g	chicken tenderloins, diced
425 g	can red kidney beans, drained
½ cup	tomato paste
½ cup	water
1 cup	grated cheese
12	tortillas

Method:

Place garlic, onion and chilli in a 3 litre casserole dish. Cook on High for 2 minutes. Stir in remaining ingredients except cheese and tortillas. Cover and cook on Med-High for 16 to 18 minutes, stirring twice during cooking. Serve in warmed tortillas topped with grated cheese.

Tip:

- Many curry recipes use finely diced potato to break down during cooking and thicken the sauce. Potato doesn't break down when cooked in the microwave. Continued cooking will dehydrate the potato. If adapting your own recipe only use one quarter of the liquid.
- Substitute 2 tablespoons of Korma curry paste for the spices and garlic in this recipe.
- When using spices in cooking, toast in the microwave for 30 to 60 seconds to release their flavour and aroma before using in a recipe.

GREEN PEPPERCORN CHICKEN

Serves: 4

Ingredients:

500 g	sliced chicken breast fillets
2 tablespoons	green peppercorns
1 tablespoon	seeded mustard
1 teaspoon	chicken stock powder
2 tablespoons	lemon juice
½ cup	cream

Method:

Place chicken in a 3-litre casserole dish. Cook on Med-High for 8 to 10 minutes stirring halfway through cooking. Mix together peppercorns, mustard, stock powder, lemon juice and cream. Pour over chicken, stir. Cook on High for 3 to 4 minutes.

THAI CHICKEN CURRY

Serves: 4

Ingredients:

1	onion, chopped
2 tablespoons	red curry paste
500 g	chicken fillets, sliced
1 tablespoon	fish sauce
1 tablespoon	brown sugar
2 cups	finely sliced vegetables
1 cup	coconut milk

Method:

Place onion and curry paste in a 3-litre casserole dish. Cook on High for 4 to 5 minutes. Add chicken and combine. Cook on Med-High for 6 minutes, stirring once during cooking. Add fish sauce, brown sugar, vegetables and coconut milk. Stir well. Cover and cook on High for 9 to 11 minutes. Serve with Jasmine rice.

APRICOT NECTAR CHICKEN

Serves: 4

Ingredients:

400 ml	apricot nectar
40 g	French onion soup mix
1	onion, diced
1 clove	garlic, crushed
½ cup	dried apricots
1 kg	chicken legs

Method:

Place all ingredients except chicken legs into a 5-litre dish. Mix well to combine. Add chicken legs and stir to coat with sauce. Cook on Med-High for 25 to 27 minutes, stirring halfway through cooking.

CHICKEN CACCIATORE

Serves: 4

Ingredients:

400 g	can diced tomatoes
¼ cup	tomato paste
1 teaspoon	minced garlic
1	onion, diced
2 teaspoons	dried oregano
1 kg	chicken drumsticks
¼	red capsicum, sliced

Method:

Place all ingredients in a 5-litre casserole dish. Stir until combined. Cover and cook on Med-High for 10 to 12 minutes. Turn chicken and stir. Cook on Med-High for 12 to 14 minutes.

CHICKEN SAN CHOY BAU

Serves: 4

Ingredients:

10	dried shiitake mushrooms
2 teaspoons	sesame oil
1	clove garlic, chopped
500 g	minced chicken
10	water chestnuts, finely chopped
227 g	can bamboo shoots, chopped
¼ cup	soy sauce
1 tablespoon	oyster sauce
2 tablespoons	dry sherry
1	small iceberg lettuce

Method:

Cover mushrooms with boiling water, stand for 30 minutes. Drain, remove stems and chop finely. Place oil and garlic in a 2 litre casserole dish, cook on High for 40 to 50 seconds. Add chicken and cook on Med-High for 5 to 6 minutes. Add remaining ingredients except lettuce and cook on Med-High for 5 to 6 minutes. Separate lettuce leaves. place tablespoons of mixture into each lettuce leaf. Serve immediately.

CHICKEN ROLLS WITH HONEY MUSTARD

Serves: 4 to 6

Ingredients:

8	chicken thigh fillets
16	prunes, pitted
8	green onions, sliced
2 tablespoons	flaked almonds
4 rashers	rindless bacon, halved lengthwise

Honey Mustard Glaze

1 tablespoon	brown sugar
1 tablespoon	French Mustard
1 tablespoon	honey
10 g	butter, melted
	ground black pepper

Method:

Open out each thigh fillet and trim away fat. Place 2 prunes, some spring onion and a few flaked almonds on each fillet. Roll fillets up and wrap a piece of bacon around each one. Secure with toothpicks. Blend all glaze ingredients together in a small bowl. Place chicken into a 3-litre dish in a single layer and brush with glaze mixture. Cook on Med-High for 16 to 20 minutes, turning halfway through cooking.

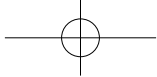

COOKING EGGS BY MICRO POWER

Boiled Eggs: Do not boil eggs in your microwave. Raw eggs boiled in their shells can explode and cause serious injury.

Poached Eggs: The membrane on egg yolks must be pierced before cooking, otherwise steam will build up and cause yolk to pop.

Scrambled Eggs: Slightly undercook scrambled eggs as they will finish cooking during standing.

BACON AND EGG IN A CUP

Serves: 1

Ingredients:

2 slices bacon
1 x 60 g egg
1 tablespoon grated cheddar cheese

Method:

Place bacon on a dinner plate between 2 sheets of paper towel cook on High for 1 to 1½ minutes. Wrap bacon around the inside of a 1-cup ramekin dish. Crack egg into centre of dish and pierce with tooth pick. Cover and cook on Medium for 50 to 60 seconds. Sprinkle with grated cheese.

POACHED EGGS

Serves: 2

Ingredients:

2 x 60 g eggs
½ cup hot tap water
dash of vinegar
pinch of salt

Method:

Place one quarter of cup of water, dash of vinegar and pinch of salt into 2 ramekin dishes or small glass bowls. Heat water on High for 30 - 60 seconds. Break egg into the water and with toothpick pierce the egg yolk twice and egg white several times. Cover dishes with plastic wrap and cook on Medium for 1 to 1½ minutes.

Stand, covered, for 1 minute before serving.

Note: The size of the eggs will alter cooking time.

CRUSTLESS CHEESE AND SPINACH PIE

Serves: 4

Ingredients:

1 bunch spinach
6 green onions, thinly sliced
500 g ricotta
2 eggs
1 tablespoon plain flour
½ teaspoon nutmeg
½ cup grated cheddar
2 tomatoes, sliced (optional)

Method:

Wash and trim thick stalks from spinach. Chop leaves roughly. Pile onto a microwave safe dinner plate and cover with plastic wrap. Microwave on High for 2 minutes. Set aside to cool slightly. Place green onions into a small bowl cover and Microwave on High for 1 minute. Squeeze out excess moisture from cooked spinach. Place ricotta, eggs, spinach, green onions, flour and nutmeg in a large bowl, season to taste and fold with a spatula until well combined. Lightly grease a round (25 cm) microwave safe pie dish. Spread mixture evenly into prepared dish and sprinkle with grated cheddar. Microwave uncovered on Medium for 15 minutes or until centre is just slightly sunken. Note: will even out on standing. Remove and stand for 2 minutes before cutting. Serve topped with sliced tomato.

SCRAMBLED EGGS

Serves: 2

Ingredients:

2 x 60 g eggs
2 tablespoons milk
pinch of salt

Method:

In a 1-litre casserole dish, beat eggs lightly with whisk. Add milk and salt. Whisk until well combined. Cover dish with plastic wrap and cook on Medium for 2 to 2½ minutes. Stir eggs and cook for further 2½ to 3 minutes. Stand, covered, for 1 minute before serving.

Cooking Tender Cuts of Meat using Micro Power

For best results, select roasts that are uniform in shape.

Place meat on a microwave rack in a suitable dish.

Beef rib roast should be placed cut-side down.

Other bone-in roasts should be placed fat-side down. Boneless roasts should be placed fat-side up. Halfway through cooking, turn roasts. Half hams should be shielded by wrapping an 8 cm wide strip of foil around the large end of the ham. Secure to the body of the ham with wooden toothpicks. Fold 3 cm over cut surface. For shank ham halves, shield shank bone by cupping it with foil. One third of the way through cooking, remove ham from oven and cut off skin. Turn fat side up and reshield edges. If desired, glaze last 10 to 20 minutes of cooking. Loosely cover baking dish with wax paper or paper towel to prevent splatter. If a large amount of juice accumulates in the bottom of the dish, drain occasionally. If desired, reserve for making gravy. Multiply the weight of the roast by the minimum recommended times per 500g. Programme Micro Power and Time.

Meats can be shielded at the beginning of cooking or halfway through cooking. If you wish to shield at the

beginning of cooking, remove foil halfway through the cooking time. Beef and pork rib roasts should be shielded around the bones. Foil should extend about 5 cm down from bones. The shank and thin ends of boneless roasts should also be shielded. Make sure foil does not touch the sides of the oven, as arcing may occur. Canned hams should be shielded on the top cut-edge with a 3 cm strip of foil. Wrap strip of foil around ham and secure to body of ham with wooden toothpicks. Fold 2 cm over cut surface. After heating, check temperature using a meat thermometer. The thermometer should not touch bone or fat. If it does, the reading could be inaccurate. Lower temperatures are found in the centre of the roast and in the muscle close to a large bone, such as a pork loin centre rib roast. If the temperatures are low, return meat to the oven and cook a few more minutes at the recommended power level. **DO NOT USE A CONVENTIONAL MEAT THERMOMETER IN THE MICROWAVE OVEN.** Let stand, covered with foil, 10 to 15 minutes. During standing time the internal temperature equalises and the temperature rises 5 °C to 10 °C.

Cooking Less-Tender Cuts of Meat by Micro Power

Less-tender cuts of meat such as pot roasts should be cooked in liquid. Use ½ to 2 cups of soup, broth, etc. per 500 g of meat. Use an oven cooking bag or covered casserole when cooking less-tender cuts of meat. Select a covered casserole deep enough so that the meat does not touch the lid. If an oven cooking bag is used, prepare the bag according to package directions. Do not use wire or metal twist-

ties. Use the nylon tie provided, otherwise, use a piece of cotton string or a strip cut from the open end of the bag. Make six 2 cm slits in top of bag to allow steam to escape. Multiply the weight of the roast by the minimum recommended minutes per 500 g as suggested in the chart below. Programme Power and Time. Turn meat over halfway through cooking. Meat should be tender when cooked.

Meat Chart for Microwave Cooking

MEAT	POWER	APPROX. COOKING TIME (minutes per 500 g)
Beef		
Roasts Medium		
Rare	Medium	8 to 10
Medium	Medium	10 to 12
Well	Medium	12 to 14
Pot Roast	Med-Low	25 to 30
Pork		
Leg of Pork	Med-High	11 to 13
Loin of Pork	Med-High	12 to 14
Ham Canned (fully cooked)	Med-High	5 to 6
Lamb		
Medium	Medium	6 to 8
Well	Medium	9 to 11

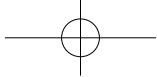

ITALIAN BEEF CASSEROLE WITH POLENTA DUMPLINGS

Serves: 4 to 6

Ingredients:

¾ cup	polenta
300 ml	boiling water
¼ cup	grated Parmesan cheese
1	onion, sliced
2	cloves garlic, crushed
1 kg	diced beef
1 tablespoon	flour
1 cup	beef stock
1	red capsicum, de-seeded, roasted, peeled and sliced
800 g	can crushed tomatoes
1 tablespoon	fresh oregano, chopped
2 tablespoons	pre-prepared pesto

Method:

Pour polenta into boiling water and stir until well combined. Cook on High for 2 minutes or until mixture leaves the sides of the dish. Stir in Parmesan cheese and allow to cool.

Place remaining ingredients, except pesto, into a 3-litre casserole dish. Stir well and cook on high for 10 minutes. Stir and continue cooking on Medium for 35 to 40 minutes, stir several times during cooking. Shape polenta into 12 balls and place them on top of the casserole. Cook on medium for 10 minutes. Serve casserole topped with pesto.

THAI BEEF CURRY

Serves: 4 to 6

Ingredients:

1	onion, thinly sliced
2 tablespoons	Thai green curry paste
500 g	thinly sliced lean beef
½	red capsicum, thinly sliced
1	carrot, thinly sliced
1	zucchini, sliced
200 g	broccoli, broken into flowerets
1 cup	coconut milk
1 tablespoon	soy sauce
1 tablespoon	lemon juice
2 tablespoons	shredded fresh basil
½ cup	roasted unsalted peanuts

Method:

Place the onion and curry paste into a 4-litre dish. Cook on High for 2 to 3 minutes. Add the beef and cook on High for 4 to 6 minutes, stirring halfway through cooking. Add the vegetables and coconut milk and cook on High for 6 to 8 minutes. Mix in the soy sauce, lemon juice and basil and serve sprinkled with peanuts.

LASAGNE

Serves: 4 to 6

Ingredients:

Meat Sauce:

500 g	minced beef
2	small onions, chopped
1 clove	garlic, chopped
425 g	tomato purée
1 cup	beef stock
¼ cup	chopped basil
1 tablespoon	cracked black pepper

Cheese Sauce:

80 g	butter
¼ cup	flour
500 ml	milk
1 cup	grated cheese
½ cup	Parmesan cheese
12	lasagne sheets, cooked
½ cup	extra grated cheese

Method:

Meat Sauce:

Place beef, onion and garlic in a 3-litre casserole dish. Cook on High for 5 to 6 minutes. Add remaining sauce ingredients. Cook on Med-High for 15 to 20 minutes, stirring several times during cooking. Set aside.

Cheese Sauce:

Melt butter in a 2-litre jug on High for 30 to 40 seconds. Add flour and mix well. Gradually stir in milk. Cook on High for 3 to 4 minutes. Stirring halfway through cooking. Add grated cheese and Parmesan cheese. Cook on High for 50 to 60 seconds. Spoon quarter of the meat sauce into the base of 25 x 25 cm deep casserole dish. Top with three lasagne sheets. Spoon another quarter of meat sauce over the lasagne sheets and spread with cheese sauce. Continue with remaining ingredients. Top with meat and cheese sauce. Sprinkle with extra cheese and cook on Med-High for 20 to 25 minutes.

SPAGHETTI MEAT SAUCE

Serves: 4 to 6

Ingredients:

500 g	minced beef
1	onion, chopped
1 teaspoon	minced garlic
425 g	can tomatoes
1 cup	tomato puree
¼ cup	red wine
1 teaspoon	dried mixed herbs
	pepper

Method:

Place beef, onion and garlic in a 3-litre casserole dish. Cook on High for 5 to 6 minutes. Add remaining ingredients. Stir. Cook on Med-High for 16 to 18 minutes. Stir halfway through cooking. Serve with spaghetti.

BEEF STROGANOFF

Serves: 4

Ingredients:

1	onion, sliced
1 teaspoon	minced garlic
1 teaspoon	paprika
750 g	rump steak sliced thinly
2 tablespoons	tomato sauce
2 tablespoons	worcestershire sauce
1	beef stock cube
1 teaspoon	paprika
1/3 cup	sour cream
200 g	sliced mushrooms

Method:

Place all ingredients (except sour cream and mushrooms) in a 3-litre casserole dish. Stir until combined. Cover and cook on Med-High for 7 to 9 minutes, stirring once during cooking. Add mushrooms. Stir and cook on Med-High for 4 to 5 minutes. Stir through sour cream.

CHINESE BEEF AND VEGETABLES

Serves: 4 to 6

Ingredients:

500 g	rump steak sliced
1 teaspoon	chopped ginger
1 clove	garlic, chopped
1 tablespoon	soy sauce
1/4 cup	Hoisin sauce
1/4 cup	sweet chilli sauce
3 cups	sliced vegetables

Method:

Place steak, ginger and garlic in a 3-litre casserole dish. Cook on High for 1 minute. Add soy sauce, Hoisin sauce and chilli sauce to meat mixture. Cook on High for 4 to 5 minutes. Add the vegetables, cover and cook on High for 3 to 5 minutes, stirring halfway through cooking.

Let stand for 5 minutes before serving.

CHILLI BEEF

Serves: 4

Ingredients:

500 g	topside beef mince
1 teaspoon	minced garlic
35 g	chilli seasoning mix
400 g	tomato purée
400 g	kidney beans, drained

Method:

Place all ingredients in a 3-litre dish. Mix well. Cook on Med-High for 15 to 17 minutes. Stir halfway through cooking. Serve in taco shells with chopped tomatoes and shredded lettuce or with a salad and crusty bread.

HINT:

It is better to cook meat for a lesser time in a recipe and add extra time if needed. This will prevent over cooking.

FRENCH ONION BEEF CASSEROLE

Serves: 4

Ingredients:

1	onion, chopped
1 teaspoon	minced garlic
200 g	diced potatoes
600 g	beef, diced
2	carrots, diced
1/3 cup	tomato paste
1 1/2 cups	beef stock
100 g	whole button mushrooms
1/4 cup	frozen peas

Method:

Place onion and garlic in a 3-litre casserole dish. Cook on High for 1 to 2 minutes. Add remaining ingredients, except mushrooms and peas. Stir until combined. Cover and cook on High for 8 minutes. Stir and cook on Medium for 28 to 30 minutes. Add mushrooms and frozen peas. Stir cook on Medium for 14 to 15 minutes.

CORNERED BEEF

Serves: 4

Ingredients:

1.5	corned silverside
1 tablespoon	brown sugar
1 tablespoon	white vinegar
1	onion, cut in half
4	cloves
6	peppercorns
1	bay leaf
5 cups	water

Method:

Rinse corned silverside under cold running water to remove excess salt. Place corned silverside in a 4-litre casserole dish. Add remaining ingredients. Cover and cook on High for 10 minutes. Turn meat, cover and cook on Med-Low for 1 1/4 to 1 1/2 hours. Stand corned silverside in cooking liquid for 10 minutes before carving.

Note: Depending on the size and shape of the silverside, it may require a further 10 to 15 minutes on Med-Low.

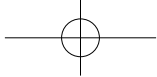

LAMB KORMA

Serves: 4

Ingredients:

1	onion, diced
500 g	lamb, cubed
1/3 cup	korma curry paste
2	large carrots sliced
250 ml	tomato puree
250 ml	beef stock
2 tablespoons	natural yoghurt

Method:

Place onion, lamb, curry paste and carrot in a 3-litre casserole dish. Cook on High for 6 minutes. Add tomato puree and beef stock and stir, cook on Medium for 40 minutes, stirring once during cooking. Stir in yoghurt and serve with basmati rice.

LAMB PILAU

Serves: 4

Ingredients:

1 tablespoon	oil
1	large onion, sliced
600 g	lean diced lamb
400 g	can tomato pieces
2 tablespoons	garam masala
1 teaspoon	dried thyme
1 cup	long grain rice
600 ml	hot chicken stock
150 g	natural yoghurt
	freshly ground black pepper

Method:

Place the onion and oil in a 3 litre dish. Cover and cook on High for 2 to 3 minutes. Add lamb, tomato pieces, garam masala, and thyme. Cover and cook on Med-High for 10 minutes. Stir. Cook on Med-High for a further 10 minutes. Add the rice and chicken stock and cook covered on Medium for a further 30 minutes or until the rice is tender. Stir in yoghurt, season with pepper and serve.

SEASONED ROAST LAMB

Serves: 4 to 6

Ingredients:

1.4 kg	leg of lamb
1 tablespoon	seeded mustard
1 tablespoon	rosemary

Method:

Place lamb fat side down on rack set in a 3-litre dish. Brush with mustard and rosemary. Cook on Medium for 30 to 35 minutes, turn halfway through cooking. Stand, covered, for 15 minutes before slicing.

GOULASH

Serves: 4

Ingredients:

1	onion, chopped
1 clove	garlic, crushed
1 tablespoon	butter
2 tablespoons	tomato paste
1/2 teaspoon	paprika
500 g	lamb, diced
1	small capsicum, diced
1 cup	beef stock
2 tablespoons	flour
2 tablespoons	water
2 tablespoons	sour cream

Method:

Place onion, garlic and butter in a 3-litre casserole dish. Cook on High for 1 to 2 minutes. Add tomato paste and paprika. Cook on High for a further 2 minutes. Add lamb, capsicum and stock. Cover and cook on Medium for 25 to 30 minutes, stirring halfway through cooking. Mix flour with 2 tablespoons of water and stir into goulash mixture. Cook on High for 1 to 2 minutes. Stir in sour cream and serve with pasta and rice.

GINGERED PORK STIR FRY

Serves: 4

Ingredients:

500 g	sliced lean pork
1/4 cup	teriyaki sauce
1 tablespoon	honey
2 teaspoons	minced ginger
2 teaspoons	cornflour
1	onion, sliced
300 g	sugar snap peas, trimmed
1	zucchini, sliced
1/2	red capsicum, sliced
2	green onions, sliced
1/2 cup	bean sprouts
1 tablespoon	toasted sesame seeds

Method:

Place pork, teriyaki sauce, honey, ginger and cornflour in a 2-litre dish. Cover and marinate in the refrigerator for 2 hours. Place onion in a 3 litre dish. Cook on High for 1 to 2 minutes. Add marinated pork and sauces and cook on Med-High for 3 to 4 minutes. Add peas, zucchini, capsicum, green onions and bean sprouts. Cook on High for 3 to 4 minutes. Sprinkle with sesame seeds and serve with noodles.

Cooking Fresh Vegetables By Micro Power

Place vegetables in a casserole dish. Add 2 to 3 tablespoons of water per 500 g of vegetables. Add salt to water or add after cooking. Do not place salt directly on vegetables. Cover dish with glass lid or plastic wrap.

Cook on High according to time recommended in charts. Halfway through cooking, stir, turn vegetables over or rearrange.

Vegetables that are to be cooked whole and unpeeled, need to be pierced to allow steam to escape. Place vegetables on a paper towel lined dinner plate. Allow to stand, covered, according to the time indicated in the charts.

Cooking Fresh Vegetables by Micro Power

Vegetables should be covered and cooked on High power for best results. Weights given are trimmed weights.

VEGETABLE	QUANTITY	COOKING PROCEDURE	APPROX. COOKING TIME (in minutes) on High
Asparagus	250 g	Covered dish with $\frac{1}{4}$ cup water	1 to 3
Beans (finely sliced)	250 g	Covered dish with $\frac{1}{4}$ cup water	3 to 5
Beetroot	4 whole (1 kg)	Covered with 1 cup water in 4-litre dish. Stand after cooking - 5 mins.	14 to 18
Broccoli	250 g	Covered dish with $\frac{1}{4}$ cup water.	4 to 6
Brussels Sprouts	250 g	Covered dish with $\frac{1}{4}$ cup water.	4 to 6
Cabbage	500 g	Shredded, with $\frac{1}{4}$ cup water in covered dish.	5 to 7
Carrots	4 (sliced finely) 250 g	With $\frac{1}{4}$ cup water in covered dish.	5 to 6
Cauliflower	500 g	With $\frac{1}{4}$ cup water in covered dish.	7 to 9
Celery	6 stalks (400 g) cut in 1 cm pieces	With $\frac{1}{4}$ cup water in covered dish.	4 to 6
Corn	2 cobs (500 g) 4 cobs (1 kg)	Brush with melted butter and cook in covered dish.	4 to 6 10 to 12
Eggplant	1 (500 g)	Dice with $\frac{1}{4}$ cup water in covered dish.	4 to 6
Mushrooms	250 g (sliced)	Cook with 2 tablespoons butter in covered dish.	2 to 4
Onions	3 (200 g)	Cut in quarters with $\frac{1}{4}$ cup water in covered dish.	5 to 6
Peas	250 g	Shell peas and place with $\frac{1}{4}$ cup water in covered dish.	3 to 5
Potatoes-Mashed -Jacket	500 g 3 Med	Peeled and quartered with $\frac{1}{4}$ cup water. Covered. Cook uncovered on paper towel lined plate.	10 to 12 7 to 9
Pumpkin	500 g	Peeled and cut into uniform pieces with $\frac{1}{4}$ cup water in covered dish.	6 to 8
Spinach/Silver Beef	250 g	Remove stem, cut leaves into small pieces. Cook with $\frac{1}{4}$ cup water in covered dish.	4 to 6
Sweet Potato	500 g	In serving size pieces with 2 tablespoons water in covered dish.	6 to 7
Turnips	500 g	Peeled and sliced finely with $\frac{1}{4}$ cup water in covered dish.	6 to 8
Tomatoes	2 (300 g)	Sliced and cooked covered.	2 to 4
Zucchini	500 g	Cut in 2 cm pieces in covered dish.	5 to 7

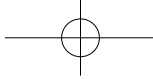

Cooking Frozen Vegetables By Micro Power

Remove vegetables from package and place in an appropriate sized container. Vegetables frozen in a pouch should be placed on a dish and the top pierced. Cook on High according to directions given in chart. Vegetables should be cooked covered with a lid or plastic wrap.

Halfway through cooking, stir, turn vegetables over or rearrange. Stir after cooking. Allow to stand for 2 to 3 minutes before serving.

Cooking Frozen Vegetables by Micro Power

VEGETABLE	QUANTITY	COOKING PROCEDURE	APPROX. COOKING TIME (in minutes) on High
Beans	250 g	Cook in covered 2-litre dish.	4 to 5
Broad Beans	250 g	Cook in covered 2-litre dish.	5 to 6
Broccoli (spears)	350 g	Cook in covered 2-litre dish.	5 to 6
Brussels Sprouts	250 g	Cook in covered 2-litre dish.	5 to 6
Carrots (baby)	250 g	Cook in covered 2-litre dish.	6 to 7
Cauliflower	500 g	Cook in covered 2-litre dish.	5 to 6
Corn (½ cob)	125 g	Cook in covered 2-litre dish.	3 to 4
Corn (cobs)	250 g	Cook in covered 2-litre dish.	5 to 6
Mixed Vegetables	250 g	Cook in covered 2-litre dish.	5 to 6
Peas	250 g	Cook in covered 2-litre dish.	4 to 6
Spinach	250 g	Cook in covered 2-litre dish.	4 to 6

Cooking Dried Beans and Peas by Micro Power

Place hot tap water in 4-litre dish. Bring hot water to the boil on High for 10 to 12 minutes. Add beans and 2 tablespoons oil to water. Cook according to directions in chart. Stir. Allow to stand, covered, for 15 to 20 minutes.

Note: Beans such as red kidney beans and lima beans should be soaked overnight before cooking. 250 g of dried beans equals about 3 cups cooked beans. Use in place of canned beans.

Cooking Dried Beans and Peas by Micro Power

ITEM	CONTAINER	TO COOK BEAN on Medium COVERED
Lentils (250 g)	4-litre dish	15 to 20 minutes
Soup Mix (250 g)	4-litre dish	20 to 25 minutes
Split Peas or Lentils (250 g)	4-litre dish	25 to 30 minutes
Beans (250 g) Soaked overnight	4-litre dish	25 to 30 minutes

RED COCONUT DHAL

Serves: 4 to 6

Ingredients:

1 cup	red lentils
1 teaspoon	turmeric
400 ml	coconut milk
250 ml	water
1 teaspoon	crushed red chilli
1 teaspoon	crushed garlic
	lemon juice to taste

Method:

Place all ingredients in a 2 litre casserole dish. Stir and cook on Medium for 20 to 22 minutes, stirring twice during cooking.

HUMMUS**Ingredients:**

1 cup	chick peas, water for soaking
3 cups	boiling water
2 tablespoons	lemon juice
2 teaspoons	turmeric
¼ cup	tahini (sesame paste)
4 cloves	garlic, minced
2 tablespoons	olive oil

Method:

Place chickpeas and water into a 4-litre casserole dish and soak overnight. Drain.

Place chickpeas and boiling water into a 3-litre casserole dish and cook on Medium for 25 to 30 minutes. Drain, process with remaining ingredients.

HONEY GLAZED CARROTS AND SUGAR**SNAP PEAS**

Serves: 4 to 6

Ingredients:

350 g	carrots
150 g	sugar snap peas, trimmed
2 tablespoons	brown sugar
2 teaspoons	butter
2 tablespoons	honey
1 tablespoon	toasted sesame seeds

Method:

Peel and thinly slice carrots. Combine all ingredients in a 2-litre casserole dish. Cover and cook on High for 6 to 8 minutes, stirring halfway through cooking. Serve.

CHICKPEA SALAD WITH CORIANDER**DRESSING**

Serves: 4 to 6

Ingredients:

1 cup	dried chick peas, water for soaking
3 cups	boiling water
1	red capsicum, diced
1	lebanese cucumber, diced
250 g	cherry tomatoes, quartered
1	Spanish onion, diced

Coriander Dressing:

½ cup	lemon juice
2 teaspoons	sugar
½ cup	chopped fresh coriander
1 teaspoon	chopped red chilli

Method:

Cover chickpeas with water and soak overnight.

Drain. Place chickpeas and boiling water into a 3-litre dish and cook on Med-High for 25 to 30 minutes.

Drain and allow to cool.

Combine remaining salad ingredients in a large bowl and mix well.

Dressing:

Combine all ingredients in a screw top jar, shake well. Pour over salad and toss well.

VEGETABLE FRITTATA

Serves: 4 to 6

Ingredients:

400 g	potatoes, thinly sliced
½	red capsicum, sliced into strips
½	green capsicum, sliced into strips
1	tomato, diced
2 tablespoons	fresh basil, chopped
4	eggs
⅓ cup	sour cream
½ teaspoon	cracked black pepper
½ cup	grated tasty cheese

Method:

Place potatoes in a 2-litre shallow dish. Cook on High for 5 to 7 minutes. Arrange capsicum in a circular pattern on top of potato sprinkle with tomato and basil. Beat together eggs and sour cream in a jug. Pour over vegetables. Cook on Medium for 4 to 5 minutes. Sprinkle with pepper and cheese and cook on Medium for 7 to 9 minutes.

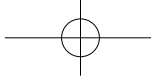

CREAMED SPINACH A

Serves: 4

Ingredients:

1	bunch spinach, roughly chopped
4	green onions, finely chopped
1	clove garlic, crushed
2 tablespoons	sour cream
	salt and pepper

Method:

Cook washed spinach leaves, green onions and garlic in a covered 3-litre casserole dish on High for 4 to 6 minutes.

To cook by Auto Cook:

Prepare as above. Select **Vegetables**,

press ▲ Weight ▼ to select weight 250 g, then press **Start**.

Drain well by squeezing between two dinner plates. Stir through sour cream. Season to taste. Cook on High for 1 to 2 minutes. Serve.

HERBED VEGETABLES

Serves: 4 to 6

Ingredients:

200 g	sliced snow peas
200 g	sliced carrots
200 g	sliced zucchini
2 tablespoons	chopped fresh parsley

Method:

Place snow peas, carrots and zucchini in a 2-litre casserole dish. Cover. Cook on High for 7 to 8 minutes, stirring once during cooking. Sprinkle with parsley. Serve.

THAI VEGETABLE CURRY

Serves: 4

Ingredients:

1	onion, sliced
2 tablespoons	green curry paste
3 cups	sliced vegetables
440 g	chick peas, drained
1 cup	coconut milk
1 tablespoon	lemon juice
1 tablespoon	soy sauce
½ cup	chopped nuts

Method:

Place onion and curry paste in a 3-litre casserole dish. Cook on High for 2 minutes. Add vegetables, chick peas, coconut milk, lemon juice and soy sauce. Cook on High for 6 to 8 minutes. Sprinkle with chopped nuts. Serve with jasmine rice.

SAVOURY BRUSSELS SPROUTS A

Serves: 4

Ingredients:

250 g	brussels sprouts
2 tablespoons	butter
150 g	bacon, finely chopped
1	onion, finely chopped
1 teaspoon	dill or basil
1 teaspoon	sugar

Method:

Wash and drain brussels sprouts. Cook in a covered 2-litre casserole dish on High for 4 to 5 minutes.

To cook by Auto Cook:

Prepare as above. Select **Vegetables**,

press ▲ Weight ▼ to select weight 250 g, then press **Start**.

Drain and set aside. Place remaining ingredients in separate 1-litre casserole dish. Cook on High for 3 to 5 minutes. Add brussels sprouts and cook on High for 1 to 2 minutes. Serve.

CAULIFLOWER AU GRATIN

Serves: 4

Ingredients:

500 g	trimmed cauliflower and cut into pieces
2 tablespoons	water
2 tablespoons	butter
2 tablespoons	flour
1 cup	milk
¼ cup	grated tasty cheese

Method:

Place cauliflower and water in a shallow casserole dish. Cover and cook on High for 6 to 8 minutes. Stand, covered, while making sauce. Place butter in a 4-cup glass jug. Cook on High for 1 to 2 minutes. Stir in flour and cook on High for 1 minute. Add milk gradually. Stir well. Cook on High for 2 to 3 minutes, stirring halfway through cooking. Drain cauliflower and pour over sauce. Sprinkle with cheese. Cook on Med-High for 1 to 2 minutes.

Note: Depending on size and arrangement of cauliflower pieces, timing will vary.

HINT:

TO SKIN TOMATOES: Cut a cross into the tomato skin. Place 1 cup of hot tap water in a 2 cup jug or bowl and heat on High for 1½ minutes or until boiling. Add 1 tomato and heat for a further 20 to 30 seconds. Remove and repeat procedure with remaining tomatoes. The skin will loosen and can be easily removed.

TOMATO VEGETABLE CASSEROLE

Serves: 4 to 6

Ingredients:

200 g	mushrooms, sliced
1	eggplant, chopped
200 g	zucchini, sliced
1	capsicum, sliced
1	onion, sliced
400 g	can tomatoes
½ cup	tomato paste
1 tablespoon	chopped basil
1 clove	garlic, minced

Method:

Place mushrooms, eggplant, zucchini, capsicum and onion in a 3-litre casserole dish. Cover. Cook on Med-High for 10 minutes. Add tomatoes, tomato purée, herbs and garlic. Re-cover and cook on High for 8 to 10 minutes.

HINT:

It is better to slightly undercook vegetables as they will soften on standing. Allow to stand, covered, with plastic wrap or a lid.

HINT:

Wrap jacket potatoes in foil after cooking. They will retain their heat for about 15 to 20 minutes.

PARMESAN ASPARAGUS

Serves: 2 to 4

Ingredients:

1	bunch of asparagus spears
2 tablespoons	water
1 tablespoon	butter
1	clove garlic, crushed
1 tablespoon	grated Parmesan cheese

Method:

Place asparagus and water in a 2-litre casserole dish. Cover and cook on High for 2 to 3 minutes. Drain. Place butter and garlic in a small dish and cook on High for 1 minute. Add drained asparagus and mix lightly. Cook on High for a further 1 minute. Sprinkle Parmesan cheese over asparagus. Serve.

ARDENNIS STYLE POTATOES **A**

Serves: 4

Ingredients:

4	medium sized potatoes
100 g	ham, finely diced
3 tablespoons	snipped chives
50 g	butter
½ cup	grated Cheddar cheese
	ground black pepper

Method:

Scrub potatoes, wash and pat dry with paper towel. Prick skins and place in a 2-litre casserole dish. Cook on High for 6 to 8 minutes.

To cook by Auto Cook:

Prepare as above. Select **Root Vegetables**, press

 Weight  to select weight 900 g, then press

Start.

Allow to cool slightly. Cut tops off potatoes and scoop out pulp from centre, leaving 1 to 2 cm in shell. Mash pulp and combine with remaining ingredients. Spoon filling back into potato shells. Place potatoes in 2-litre casserole dish. Cook on High for 2 to 3 minutes.

CHEESY MASHED POTATOES

Serves: 4

Ingredients:

500 g	potatoes, peeled and diced
¼ cup	water
⅓ cup	milk
¼ cup	grated cheese

Method:

Place potatoes and water in a 2-litre casserole dish. Cover and cook on High for 10 minutes. Drain. Mash potatoes with milk and grated cheese. Mix well. Cook on High for 1 minute. Stir well before serving.

POTATO BAKE

Serves: 4 to 6

Ingredients:

750 g	peeled and sliced potatoes
300 ml	cream
¼ cup	milk
3	green onions, sliced
2	bacon rashers, chopped
½ cup	grated cheese

Method:

Combine potatoes, cream and milk in a 2-litre casserole dish. Cook on High for 15 to 18 minutes. Top with green onions, bacon and cheese. Cook on High for 5 minutes.

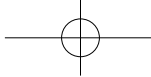

Cooking Rice by Micro power

Follow directions in chart for recommended dish size, amounts of water and cooking time. Add rice to water. Add salt and butter according to package directions. Cook on High for time recommended in

chart. Allow to stand, covered, before serving. For special rice, substitute beef or chicken stock for water. Add cooked onion, mushrooms or crumbled bacon before serving.

Cooking Rice by Micro Power

ITEM	CONTAINER	AMOUNT OF WATER	APPROX. TIME TO COOK GRAIN on High UNCOVERED (in minutes)	STANDING TIME (in minutes)
RICE Quick Cook Brown (1 cup)	2-litre dish	1½ cups	12	5
Brown (1 cup)	3-litre dish	3 cups	27 to 32	10
Long Grain (1 cup)	2-litre dish	2 cups	14 to 16	5
Short Grain (1 cup)	2-litre dish	2 cups	14 to 16	5
Jasmine (1 cup)	3-litre dish	2 cups	14 to 16	5

Cooking Pasta by Micor power

Follow directions in chart for recommended dish size, amount of water and cooking time. Boil water, with 1 teaspoon salt and 1 tablespoon oil. Add pasta and cook for time recommended in chart. Cook on High.

Test pasta for desired cooking before adding more time. Slightly undercook pasta that will be heated again in casserole. Stir and let stand, uncovered, 5 minutes.

Cooking Pasta by Micro Power

ITEM	CONTAINER	AMOUNT OF BOILING WATER	APPROX. TIME TO COOK PASTA on High UNCOVERED (in minutes)	STANDING TIME (in minutes)
Dried Fettuccine (250 g)	4-litre dish	6 cups	10 to 12	5
Elbow Macaroni, shells, etc. (250 g)	3-litre dish	4 cups	12 to 14	5
Fresh Spaghetti, Fettuccine (375 g)	4-litre dish	6 cups	6 to 8	5
Dried Spaghetti (250 g)	4-litre dish	4 cups	12 to 14	5
Fresh Tortellini, Ravioli (250 g)	4-litre dish	4 cups	7 to 9	5
Fresh Gnocchi (375 g)	4-litre dish	6 cups	6 to 8	5

Cooking Dried Noodles by Micro Power

Follow directions in chart recommended dish size, amount of water and cooking time. Add 1 tablespoon of oil to water to prevent noodles from sticking together. Add noodles and cook for time recommended in chart. Cook noodles on High. Test

noodles for desired cooking before adding extra time. Slightly undercook noodles that will be cooked again in a stir-fry or recipe. Always drain noodles immediately after cooking or they may overcook on standing.

Cooking Pasta by Micro Power

ITEM	CONTAINER	AMOUNT OF BOILING WATER	APPROX. TIME TO COOK NOODLES on High UNCOVERED (in minutes)	INSTRUCTION
2 minutes noodles (85 g)	1-litre	500 ml	2 to 3	drain immediately
Long Life Asian Noodles (250 g)	3-litre	1 litre	5 to 6	drain immediately
Rice Vermicelli (125 g)	2-litre	1 litre	3 to 4	drain immediately

FRAGRANT COCONUT RICE A

Serves: 4 to 6

Ingredients:

1 onion, chopped
2 cups long grain rice
500 ml chicken stock
400 ml coconut milk
1 teaspoon turmeric

Method:

Place all ingredients in a 5-litre casserole dish. Stir. Cook on High for 20 to 22 minutes. Cover and let stand 10 minutes before serving.

To cook by Auto Cook:

Prepare as above. Select **Rice**, press

▲ Weight ▼ to select 2 cups, then press **Start**.

SEASONED RICE A

Serves: 4 to 6

Ingredients:

1 onion, chopped
1 cup long grain rice
1 teaspoon thyme
1½ cups chicken stock
¼ cup toasted slivered almonds

Method:

Place onion, rice, thyme and chicken stock in a 3-litre casserole dish. Cook on High for 14 to 16 minutes. Stir, cover, and let stand for 10 minutes. Stir through slivered almonds and serve hot.

To cook by Auto Cook:

Prepare as above. Select **Rice**, press

▲ Weight ▼ to select 1 cups, then press **Start**.

CHICKEN AND ASPARAGUS RISOTTO

Serves: 4

Ingredients:

300 g fresh asparagus, chopped
2 tablespoons olive oil
1½ cups arborio rice
1 clove garlic, crushed
4 cups boiling chicken stock
2 cups coarsely chopped cooked chicken
¼ cup grated fresh parmesan cheese
¼ cup cream
ground black pepper
coarsely grated parmesan cheese

Method:

Place asparagus into a 2-litre dish and cook on High for 1 minute. Set aside. Place oil, rice and garlic in a large microwave safe bowl. Cook covered on High for 1 minute. Add 2 cups of boiling chicken stock, cook on High for 5 minutes. Stir twice during cooking. Add remaining chicken stock and cook on High for another 5 minutes. Add remaining ingredients along with asparagus and stir into risotto. Cook covered on High for 2 minutes. Stand for 5 minutes. Serve topped with extra parmesan and black pepper.

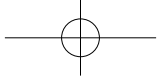

SALMON KEDGEREE

Serves: 4

Ingredients:

1 cup	basmati rice
1½ cups	water
60 g	butter
1	onion, diced
2 tablespoons	mild curry powder
2 tablespoons	lemon juice
4	hard boiled eggs, quartered
400 g	can salmon, drained and flaked
	salt and pepper
	parsley, chopped

Method:

Place rice and water in a 2 litre casserole dish. Cook on Med-High for 12 minutes. In a separate dish, melt butter on High for 1 minute. Add onion and cook on High for 1 to 2 minutes. Add curry powder and lemon juice, stir until well combined. Add rice and mix well to coat all the rice grains. Chop half the eggs roughly and stir through the rice with the salmon. Season. Heat on High for 3 to 4 minutes. Serve garnished with remaining egg and chopped parsley.

SAUSAGE & BEAN STUFFED CAPSICUMS

Serves: 4

Ingredients:

250 g	thin Italian sausages
1	small onion, chopped
2 tablespoons	tomato paste
1 tablespoon	chopped parsley
440 g	red kidney beans, drained
½ cup	cooked long grain rice
4	medium red capsicum
¼ cup	tomato paste, extra
1 tablespoon	grated Parmesan cheese

Method:

Place sausages onto a paper towel lined dinner plate. Cook on High for 2 minutes, turn and cook for a further 2 minutes. Set aside. Place onion and tomato paste into a medium microwave safe bowl. Cook uncovered on Med-High for 1 minutes. Remove skins from sausages and cut sausages into 1cm slices. Stir through onion mixture along with parsley, beans and rice. Remove tops from capsicum. Take out the seeds and white membrane and discard. Fill capsicum with stuffing mixture. Place into a shallow sided microwave safe dish. Blend together extra tomato paste with half a cup of water. Pour over and around capsicum. Cook uncovered on High for 12 to 14 minutes. Rotate halfway through cooking. Sprinkle each capsicum with Parmesan and cook on High for a further 2 minutes.

Tip: substitute any thin sausages Freeze leftover rice then defrost on High for 2 minutes per cup.

PENNE PUTTANESCA

Serves: 4

Ingredients:

500 g	Penne Pasta
2 litres	boiling water
1 tablespoon	olive oil
3 cloves	garlic, crushed
1 teaspoon	dried chilli flakes
1 kg (approx 5)	tomatoes, roughly chopped
200 g	kalamata olives, pitted
8	anchovy fillets, drained and chopped
½ cup	capers, drained and rinsed
½ cup	flat leaf parsley, chopped
2 tablespoons	finely shredded basil leaves

Method:

Place pasta and boiling water into a 4-litre dish. Stir and cook on High for 12 to 14 minutes or until tender. Drain and set aside. Place oil and garlic into a 2 litre dish and cook on High for 1 minutes. Stir in chilli and tomatoes. Cover and cook on High for 5 minutes, stir halfway through cooking. Add remaining ingredients and cook on High for a further 10 minutes or until tomatoes break down and sauce has thickened. Stir sauce into pasta. Cover and cook on High for 2 to 3 minutes to heat through. Season and serve topped with extra basil leaves or parsley.

CREAMY SUN-DRIED TOMATO PENNE A

Serves: 4

Ingredients:

250 g	penne
5 cups	boiling water
½ cup	sun-dried tomatoes in oil, drained
1 cup	basil leaves
¼ cup	toasted pinenuts
½ cup	grated parmesan cheese
300 ml	cream
½ cup	sliced ham
¼ cup	grated parmesan cheese, extra

Method:

Place pasta and water in a 4-litre casserole dish. Cook on High for 14 to 16 minutes, or cook by **Auto Cook**. While pasta is cooking, prepare sauce. Place all ingredients except ham and extra parmesan cheese into a food processor. Process until smooth. Drain pasta and add sauce. Serve topped with ham and extra parmesan cheese.

To cook by Auto Cook:

Prepare as above. Select **Pasta**, press

▲ Weight ▼ to select 250 g, then press **Start**.

SPAGHETTI WITH CHILLI TOMATO SAUCE

Serves: 4

Ingredients:

250 g	spaghetti
4 cups	boiling water
1 tablespoon	olive oil
1	onion, finely chopped
2 cloves	garlic, crushed
425 g	crushed tomatoes
2 teaspoons	crushed chillies
2 tablespoons	fresh chopped basil
1 teaspoon	pepper

Method:

Place spaghetti and water in a 3-litre casserole dish. Cook on High for 12 to 14 minutes, or cook by Auto Cook. Stand, covered, for 2 minutes. Drain. Place oil, onion and garlic in a 4-cup jug. Cook on High for 1 to 2 minutes. Add tomatoes, chillies, basil and pepper. Stir until combined. Cover and cook on Med-High for 10 to 15 minutes, stirring halfway through cooking. Serve with spaghetti.

To cook by Auto Cook:

Prepare as above. Select **Pasta**, press

 Weight  to select 250 g, then press **Start**.

MACARONI AND CHEESE

Serves: 4 to 6

Ingredients:

40 g	butter
1	onion, finely chopped
2 tablespoons	flour
2 cups	milk
1 cup	grated tasty cheese
6 cups	cooked macaroni, drained well
½ cup	extra grated tasty cheese
	paprika

Method:

Place butter and onion in a 2-litre casserole dish and cook on High for 3 to 4 minutes. Add flour, mix well and cook on High for 1 minute. Blend in milk and cook on High for 4 to 5 minutes, stirring halfway through cooking. Add cheese to sauce. Place macaroni and sauce in a 3-litre casserole dish. Mix well. Top with extra cheese and sprinkle with paprika. Cook on High for 6 to 8 minutes.

Note: Macaroni can be cooked using Auto Cook function.

TERIYAKI TOFU VEGETABLE NOODLES

Serves: 4

Ingredients:

1 tablespoon	sesame oil
350 g	firm tofu, diced
1	onion, cut into petals
300 g	stir fry vegetables
1 tablespoon	hoisin sauce
1 tablespoon	teriyaki sauce
85 g	2 minute noodles
2 cups	boiling water

Method:

Place oil, tofu and onion in a 3-litre dish and cook on High for 2 to 3 minutes. Add vegetables and sauces and cook on High for 3 to 4 minutes, stirring once during cooking. Place noodles and water in a 2-litre bowl and cook on High for 2 minutes. Stir and drain. Toss noodles through tofu and vegetables and serve.

HONEY SOY CHICKEN AND NOODLES

Serves: 4

Ingredients:

500 g	chicken fillets, sliced
¼ cup	soy sauce
2 tablespoons	honey
2 teaspoons	minced garlic
2 cups	finely sliced vegetables
400 g	udon noodles
½ cup	boiling water

Method:

Combine chicken, soy, honey and garlic in a 2-litre bowl for 30 minutes. Cook chicken on Med-High for 4 to 5 minute, stirring once during cooking. Add vegetables and cook on High for 3 to 4 minute. Place noodles and water in a bowl cover with plastic wrap cook on Med-High for 1 to 2 minutes. Drain. Toss noodles in with chicken mixture and serve.

SATAY BEEF WITH NOODLES**Ingredients:**

500 g	rump steak, sliced
1	onion, sliced
1 teaspoon	crushed garlic
½ cup	crunchy peanut butter
¼ cup	sweet chilli sauce
⅔ cup	coconut milk
2 tablespoons	lemon juice
1 teaspoon	sugar
2	green onions, sliced
500 g	fresh Singapore noodles
½ cup	boiling water

Method:

Place steak, onion and garlic in a 3-litre casserole dish cook on High for 2 to 2½ minutes. Add remaining ingredients except green onions and noodles and stir until combined. Cook on High for 6 to 8 minutes. Stirring halfway through cooking. Place noodles with water in a 2.5-litre dish cover and cook on Med-High for 2 to 3 minutes. Drain and rinse under cold water. Drain well. Toss beef mixture through noodles and top with green onions. Cook on HIGH for 1 to 2 minutes.

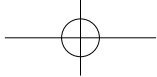

Cakes, Desserts and slices can successfully be cooked in the microwave oven if a few simple rules are followed see individual recipes for instructions.

COOKING CAKES BY MICRO POWER

- The texture of cakes cooked in the microwave oven is not the same as cakes cooked in a conventional oven, but it is a convenient way of cooking cakes.
- Do not use metal cake tins, plastic dishes and pyrex, give the best results when cooking cakes. Grease the dish and line with paper towel or bake paper to absorb excess moisture.
- Round or oval shaped dishes produce the most even cooking results. Square cakes may need the corners shielded with foil to prevent overcooking.
- Choose light coloured cakes that can be iced or substitute brown sugar for white sugar and sprinkle the top of cake with spices to give a darker appearance.
- Do not fill cake pans more than half full. Microwaved cakes rise substantially more than conventionally cooked cakes.
- Cakes need to be well mixed but do not over beat. Creaming with an electric mixer or food processor is not necessary. Use a fork to mix as the microwave aerates the mixture as it cooks.
- Do not cover cakes as the top will steam.
- Cakes should be removed from the oven just before they look cooked as the cooking process will finish during standing time.
- Chocolate cakes cook slightly faster than plain cakes.
- Cakes containing a large amount of whisked egg white will not cook successfully in the microwave oven.

PACKET CAKE

Ingredients:

1 packet cake mix (340 g)
Ingredients as recommended by manufacturer.

Method:

Mix cake and other ingredients with a metal spoon. **DO NOT OVERBEAT.** Pour into 20 cm round dish that has been lightly greased and lined with paper. Cook on Med-High for 7 to 8 minutes. Stand and allow to cool before removing.

Variations:

- 1 tablespoon jam added to batter before cooking.
- Add 1 cup sour cream to batter and halve water suggested by manufacturer.
- Half a cup chopped nuts, ¼ cup brown sugar and 1 teaspoon cinnamon. Mix and place on base of cake dish before cooking cake.
- Melt two tablespoons honey and 30 g butter in glass jug on High for 30 to 60 seconds. Pour over just baked buttercake. Sprinkle with cinnamon.
- Serve warm with cream or custard as a dessert or serve cold with cream as tea cake.
- A quarter cup of toasted muesli mixed with 1 tablespoon marmalade and placed in the base of the dish.

Tip: Packet cakes are best mixed by hand as the microwave will do the aerating.

COOKING FRUIT BY MICRO POWER

FRUIT - Peel, slice, chop into even sized pieces. Place in shallow heatproof dish on turntable.				
Apples - poached	500 g	High	8	Add 300 ml of water. Only half fill dish. Cover.
Apples - stewed	500 g	High	6	Only half fill dish. Cover.
Peaches - poached	500 g	High	4 - 5	Add 300 ml of water. Only half fill dish. Cover.
Pears - poached	500 g	High	6 - 7	Add 300 ml of water. Only half fill dish. Cover.
Plums - poached	500 g	High	8	Add 300 ml of water. Only half fill dish. Cover.
Plums - stewed	500 g	High	8 - 10	Add 30 ml (2 tbsp) of water. Only half fill dish. Cover.
Rhubarb - stewed	500 g	High	5	Only half fill dish. Cover.

CHOCOLATE BROWNIES

Makes: 1 x 20 cm square slice pan

Ingredients:

125 g	butter
200 g	chocolate
1 cup	caster sugar
1 teaspoon	vanilla essence
3	eggs
1 cup	plain flour

Method:

Grease and line 20 cm square pyrex dish. Melt butter and chocolate in 2-litre dish on Med-High for 2 minutes. Stir in sugar, vanilla essence, eggs and flour. Spread into prepared dish. Cook on Med-High for 7 to 8 minutes. Refrigerate until cold. Cut into squares.

RHUBARB, APPLE & GINGER COMPOTE

Serves: 4

Ingredients:

300 g	rhubarb, trimmed cut to 3 cm lengths
2	apples, peeled, cored and diced
30 g	crystallised ginger, thinly sliced
½ cup	caster sugar
1	orange, grated rind and juice

Method:

Place all ingredients into a 2-litre microwave safe dish. Stir to dissolve sugar. Cook on High for 8 to 10 minutes or until fruit is softened.

ROCKY ROAD

Makes: 1 x 20 cm square slice

Ingredients:

250 g	dark or milk chocolate
40 g	butter
250 g	packet marshmallows, halved
1 cup	unsalted peanuts
1½ cups	flaked coconut
100 g	Turkish delight, chopped

Method:

Melt chocolate and butter in a large bowl on Medium for 2 to 3 minutes. Add remaining ingredients and mix well. Pour into greased 20 cm square pan. Refrigerate until set. Cut or break into pieces to serve.

CHERRY KUECHEN

Serves: 4 to 6

Ingredients:

Base	
1 (340 g) pkt	buttercake mix
½ cup	toasted coconut
125 g	melted butter
1	egg
Filling:	
425 g	can pitted cherries, drained
Topping:	
300 ml	carton sour cream
1	egg
2 tablespoons	sugar
½ teaspoon	cinnamon

Method:

Combine cake mix, coconut, melted butter and egg. Press into 27 cm flan dish. Cook on High for 3 minutes. Arrange cherries over base. Combine sour cream, egg and sugar and pour over cherries. Sprinkle with cinnamon. Cook on Medium for 9 to 11 minutes.

MOCHA FUDGE

Makes: 64 x 2.5 cm square pieces

Ingredients:

395 g	can sweetened condensed milk
300 g	dark chocolate melts
1 teaspoon	vanilla extract
1 teaspoon	instant coffee powder
64	chocolate coated coffee beans

Method:

Grease a square (20 cm) cake pan, set aside. Place condensed milk and chocolate in a 1.5-litre microwave safe and heatproof bowl. Cook on Med-High for 2 minutes. Stir in vanilla and coffee. Mix until well combined. Cook on Medium for 2 minutes. Stir and pour into prepared pan. Arrange coffee beans evenly over the fudge. Chill for 2 hours or until set. Cut into 2.5 cm squares to serve.

Tip:

Chocolate coated coffee beans are available from specialty coffee shops.

HINT:

To toast coconut:
Place ½ cup of coconut on a pyrex plate. Cook on HIGH for 2 to 3 minutes, stirring every minute.

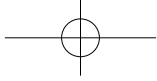

MOCHA CARROT CAKE

Serves: 4 to 6

Ingredients:

1 cup self-raising flour
 ½ teaspoon bicarbonate of soda
 ½ cup caster sugar
 ½ cup crushed pineapple
 1 cup grated carrot
 ¾ cup chopped pecan nuts
 60 g chocolate
 2 eggs
 ⅓ cup oil

Icing

60 g cream cheese
 20 g butter
 1½ cups icing sugar
 1 tablespoon lemon juice
 ¼ cup chopped pecan nuts

Method:

Place flour, bicarbonate of soda, sugar, pineapple, carrot and pecan nuts in a bowl. Place chocolate into a small bowl and cook on Medium for 40 to 60 seconds. Stir halfway through. Add melted chocolate, eggs and oil to flour mixture. Mix until well combined. Grease a microwave safe ring dish and cook on Med-High for 6 to 8 minutes. Let stand, covered, for 5 minutes before turning out to cool. Beat together all icing ingredients except pecan nuts. Spread icing over cooled cake and sprinkle with pecan nuts.

CHOCOLATE SELF SAUCING PUDDING

Serves: 4

Ingredients:

1 cup self raising flour
 1 tablespoon cocoa powder
 ⅓ cup caster sugar
 ¼ cup milk
 1 teaspoon vanilla essence
 50 g chocolate
 100 g butter
 ¾ cup brown sugar
 2 tablespoons cocoa, extra
 ½ cup water

Method:

Sift flour and cocoa into a bowl. Add sugar, milk and vanilla essence. Mix well and set aside. Melt chocolate and butter in a separate microwave safe container and pour it into the mixture while hot. Mix well. Combine brown sugar, cocoa and water in a jug. Spread mixture into base of a 2-litre casserole dish. Cook on High for 4 to 6 minutes. Do not use plastic wrap or lid.

STEAMED JAM PUDDING

Serves: 4

Ingredients:

2 tablespoons jam
 100 g butter
 ⅓ cup caster sugar
 2 eggs
 ¾ cup self raising flour
 ¼ cup milk

Method:

Spoon jam into bottom of a 2-litre pudding bowl. Cream butter and sugar in a separate bowl until light and fluffy. Add eggs (one at a time), beating well after each addition. Fold in flour alternately with milk. Mix until well combined. Pour mixture over jam. Smooth top and cook on High for 6 to 7 minutes. Let stand, covered, for 5 minutes before serving.

BREAD AND BUTTER PUDDING

Serves: 4 to 6

Ingredients:

⅓ cup sultanas
 ¼ cup rum
 70 g butter, softened
 10 slices fruit loaf
 4 eggs
 1½ cups milk
 300 ml cream
 ⅓ cup brown sugar

Method:

Grease a 1.2 litre microwave oven safe dish. Combine sultanas and rum in a small bowl. Heat on High for 1 minute. Set aside. Butter both sides of all bread slices. Remove the crusts and cut into triangles. Beat together eggs, milk and cream, add liquid from drained sultanas. Layer one third of the bread evenly over the base of the 4 cup dish. Sprinkle with half the sultanas and one third of the brown sugar. Repeat with another layer of bread, sultanas and brown sugar and top with the remaining bread. Pour about two thirds of the egg mixture over the bread and allow to stand for 20 minutes until the liquid is absorbed. Pour over the remaining egg mixture and sprinkle with brown sugar. Elevate on a microwave safe rack and cook on Med-High for 30 to 35 minutes. Allow to stand for 10 minutes before serving with cream or ice cream.

QUICK MIX CHOCOLATE CAKE

Serves: 4 to 6

Ingredients:

1 cup	self-raising flour
1 cup	caster sugar
2 tablespoons	cocoa
3 tablespoons	butter, softened
2	eggs
1/3 cup	milk

Method:

Sift all dry ingredients into a bowl. Add butter, eggs and milk. Beat with wire whisk for 1 to 2 minutes. Grease a 2-litre plastic ring mould and line with paper towel. Pour mixture into mould and cook on Med-High for 8 to 10 minutes. Stand, covered, for 5 minutes before turning out. Cool on wire rack.

Tip: To soften butter cook on Medium for 10 to 20 seconds.

CINNAMON POACHED PEARS

Serves: 4

Ingredients:

1/2 cup	water
1/2 cup	caster sugar
1/2 teaspoon	cinnamon
4	pears, peeled and sliced

Method:

Combine water, caster sugar and cinnamon in a 1-litre jug. Cook on High for 2 minutes. Place the pears in a 2-litre dish. Pour over syrup and cover. Cook on High for 6 to 8 minutes.

PEACH CRUMBLE

Serves: 6 to 8

Ingredients:

125 g	butter
1 cup	flour
1/2 cup	caster sugar
2 cups	toasted muesli
1 cup	shredded coconut
1 teaspoon	cinnamon
810 g	can peach slices, drained

Method:

Place butter in a 2-litre jug. Cook on Medium for 1 minute. Add flour, sugar, muesli, coconut and cinnamon, stir until combined. Place peaches into a 2-litre casserole dish. Place crumble mixture on top of peaches and cook on High for 10 to 12 minutes. Serve with cream or ice cream.

BANANA LOAF

Serves 4 to 6

Ingredients:

90 g	butter
3/4 cup	brown sugar
1	egg
2	ripe bananas, mashed well
3/4 cup	grated carrot
1 1/2 cups	self-raising flour
1/3 cup	milk

Method:

Cream butter and sugar until light and fluffy. Add egg and beat well. Add banana and carrot. Add sifted flour and milk to mixture alternately. Mix until well combined. Grease and line with grease proof paper, 20 cm x 10 cm loaf dish. Pour batter into dish and cook on Medium for 9 to 11 minutes. Stand, covered, with plastic wrap on wire rack to cool.

Tip: To prevent corners from overcooking, cover ends carefully with foil.

HINT:**TO MELT CHOCOLATE:**

Place 100 g broken chocolate in a 4-cup glass jug and heat on Medium for 1 to 2 minutes. As chocolate holds its shape after heating, stir and stand before adding extra cooking time.

APPLE CRUMBLE

Serves: 4

Ingredients:

780 g	can pie apples
1/2 cup	rolled oats
1/4 cup	plain flour
1/2 cup	desiccated coconut
1/2 cup	brown sugar
1	teaspoon cinnamon
60 g	butter

Method:

Place apples in the base of 1-litre casserole dish. Place remaining ingredients (except butter) in mixing bowl. Melt butter in 2-cup jug on High for 40 to 60 seconds. Combine melted butter with dry ingredients and mix well. Spread evenly over apples. Cook on High for 5 to 8 minutes.

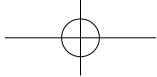
**COCONUT CREAMED RICE**

Serves: 4

Ingredients:

1 cup	arborio rice
300 ml	coconut milk
20 g	unsalted butter
½ cup	sugar
100 ml	coconut milk, extra to serve
1	banana, to serve
½ cup	shredded coconut, toasted

Method:

Wash and drain rice. Place rice, 300 ml of coconut milk, 300 ml water, butter and sugar into a 2.5 L deep microwave safe bowl or jug, stir to combine. Microwave uncovered on High for 21 minutes, stirring every 7 minutes. Remove and stir well, stand for 5 minutes.

Note: Rice will absorb excess liquid on standing. Serve warm in individual bowls drizzled with extra coconut milk, banana slices and shredded coconut.

FRUIT MINCE

Serves: 4

Ingredients:

250 g	mixed dried fruit
440 g	can crushed pineapple and juice
1	cooking apple peeled, cored and grated
1 cup	brown sugar
1 tablespoon	brandy
1 teaspoon	nutmeg
1 teaspoon	cinnamon
1 tablespoon	cornflour
¼ cup	water

Method:

Combine all ingredients (except cornflour and water) in a 2-litre casserole dish. Cook on Med-High for 3 to 5 minutes. Blend cornflour with water and stir into fruit mixture. Cook on High for 3 to 5 minutes. Stir. Cool. Bottle and seal or use immediately.

CHOCOLATE PÂTÉ

Makes 24 x 8 cm loaf tin

Ingredients:

300 g	dark chocolate
400 g	condensed milk
1 cup	brazil nuts
½ cup	hazel nuts
⅓ cup	glace cherries
½ cup	sultanas

Method:

Break chocolate into pieces and place with condensed milk in a 2-litre dish. Cook on Med-High for 3 to 5 minutes, stirring twice during cooking. Fold through nuts and fruits. Line a 24 x 8 cm loaf tin with foil and pour in the mixture. Chill for several hours or until set. Turn out and serve thinly sliced.

INDIVIDUAL CHRISTMAS PUDDING

Makes: 8

Ingredients:

100 g	sultanas
150 g	raisins
50 g	craisins
100 g	dates, chopped
100 g	dried figs, chopped
50 g	glace ginger, chopped
½ cup	brandy
125 g	butter
¾ cup	firmly packed brown sugar
2	eggs
½ teaspoon	cinnamon
½ teaspoon	mixed spice
½ teaspoon	nutmeg
½ cup	plain flour
½ cup	pie apple
¾ cup	fresh breadcrumbs
1 tablespoon	golden syrup
1 tablespoon	parisienne essence

Method:

Place all dried fruits and brandy into a 2-litre bowl. Mix and cook uncovered on Defrost for 10 minutes. Stir halfway through cooking. Cool. Beat butter and sugar in a large bowl with an electric mixer until light and fluffy. Add eggs, one at a time, beating between each addition. Stir in cooled fruits, then remaining ingredients. Grease 4 x 200 ml microwave safe cups. Place half a cup of mixture into each cup, pushing mixture in firmly. Smooth over the top of puddings with the back of a spoon. Place cups evenly around the edge of the microwave turntable and cook uncovered on Defrost for 20 minutes. Stand for 5 minutes before turning out. Repeat with remaining mixture. Serve with cream or custard.

MINCE PIES • CAUTION

Take care not to overheat mince pies, otherwise burning can occur due to the high fat and sugar content of the filling. Check the temperature of the filling before consuming to avoid burning your mouth. REMEMBER even if the pastry is cold to the touch, the filling will be piping hot and will warm the pastry through.

ORANGE TRUFFLES**Ingredients:**

200 g	dark chocolate bits
30 g	butter
¼ cup	evaporated milk
⅓ cup	icing sugar, sifted
¼ cup	chopped nuts
1 tablespoon	orange liqueur
½ cup	drinking chocolate powder

Method:

Place chocolate bits and butter in a 1-litre dish. Cook on Med-High for 1 to 2 minutes, stirring halfway through cooking. Add evaporated milk, stir until combined. Stir in icing sugar, nuts and orange liqueur. Refrigerate covered for 1 hour. Roll tablespoons mixture into small balls. Toss in drinking chocolate powder. Refrigerate until serving.

Preserving Precautions

Do not use your oven for home canning or the heating of any closed jar. Pressure will build up and the jar may explode. In addition, the microwave oven cannot maintain the food at the correct canning temperature. Improperly canned food may spoil and be dangerous to consume.

Jars and Bottles

Jars and bottles can be used to warm food to serving temperature. If the lid is removed first. Cooking should not be done in these containers since most are not heat resistant and during extended heating times, heat from food would cause cracking or breaking.

Thermometers are available for use in microwave ovens. DO NOT USE CONVENTIONAL MERCURY TYPE CANDY OR MEAT THERMOMETERS in food while cooking in the microwave oven. Alternatively, a conventional meat thermometer may be used after the food is removed from the oven.

Sterilizing Jars

Jam jars can be sterilized by microwave ready for your jams. Half fill with water and heat them on HIGH power until water boils (approx.3 mins, for 2 jars). Empty and drain upside down on kitchen paper. The jars should be warm when filled with jam.

TOMATO CHUTNEY

Makes: 3 cups (750 ml)

Ingredients:

250 g	onion, finely chopped
1.5 kg	ripe tomato, skins removed and chopped
1 teaspoon	salt
1 teaspoon	paprika
	pinch cayenne pepper
150 ml	malt vinegar
175 g	sugar

Method:

Place onions in a 3-litre dish. Cover. Cook on High for 4 to 5 minutes. Add tomatoes. Cover. Cook on High for 5 to 6 minutes. Add salt, spices and vinegar. Stir well. Cook on High for 10 minutes, stirring halfway through. Add sugar, stir well and cook on Med-High for 35 to 40 minutes. Stirring occasionally. Pour into sterilised jars and seal.

LEMON BUTTER

Makes: 1 cups (250 ml)

Ingredients:

½ cup	lemon juice
1 tablespoon	lemon rind
⅓ cup	sugar
3	egg yolks
1 tablespoon	butter
1 tablespoon	cornflour

Method:

Blend all ingredients in a 4-cup glass jug. Cook on Medium for 4 to 5 minutes, stirring every minute. Pour into hot sterilised jars and seal immediately.

LEMON LIME CORDIAL

Makes: approximately 1.5 litres of undiluted cordial

Ingredients:

10	large lemons
6	limes
4 cups	sugar
2 cups	water
2 teaspoons	citric acid

Method:

Squeeze juice from lemons and limes. Place in a 3 to 4-litre dish with the remaining ingredients. Cook on High for 8 to 10 minutes. Stir 2 to 3 minutes during this cooking time to dissolve sugar. Cook on High for 25 to 30 minutes, or until the mixture has become a syrupy consistency. Set aside to cool. Pour into bottles and seal. Store in the refrigerator and serve with cold water, soda or mineral water and fresh mint leaves if desired.

HOT COCOA

Makes: 1 cup

Ingredients:

2 teaspoons	cocoa powder
1 teaspoon	sugar
2 tablespoons	water
1 cup	milk

Method:

Combine cocoa, sugar and water in a heatproof cup. Cook on High for 10 to 15 seconds. Stir in milk. Heat on Med-High for 2 to 3 minutes.

GINGER TEA

Serve: 2

Ingredients:

5 cm	piece ginger
1	lemon, sliced
2	teabags
1 cup	mint leaves
2 cups	water

Method:

Peel and slice ginger and place into a 2-cup jug with remaining ingredients. Heat on High for 3 to 4 minutes. Allow standing for 5 minutes to infuse. Strain and serve.

HOT LEMON AND HONEY DRINK

Makes: 1

Ingredients:

	juice of ½ lemon
1 tablespoon	honey
1 cup	water

Method:

Mix all ingredients in a 2-cup heatproof jug. Heat on High for 1 to 2 minutes. Stir well.

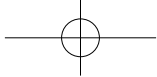

BASIC WHITE SAUCE

Makes: 1 cup

Ingredients:

2 tablespoons butter
 2 tablespoons flour
 salt and white pepper
 1¼ cups milk

Method:

Place butter in a 4-cup jug. Cook on High for 30 to 40 seconds. Stir in flour, salt and pepper. Gradually add milk, stirring until smooth. Cook on High for 2 minutes, stirring every minute.

Tip: For cheese sauce, stir in ½ cup grated cheese once sauce has thickened.

GRAVY

Makes: 2 cups

Ingredients:

2 tablespoons dripping or pan juice
 1 small onion, finely chopped
 2 tablespoons flour
 1 tablespoon tomato paste
 1½ cups beef stock
 salt and pepper

Method:

Place dripping or pan juices and onion in a 2-cup jug. Cook on High for 2 minutes. Add flour, tomato paste and half of the beef stock. Stir well. Cook on High for 2 minutes. Add remaining stock. Stir well and cook on High for a further 2 minutes. Season with salt and pepper. Serve with the meat of your choice.

CHEESE SAUCE

Makes: 1½ cups

Ingredients:

40 g butter
 2 tablespoons flour
 1½ cups milk
 ½ cup grated cheese

Method:

Melt butter in 1-litre jug on High for 30 seconds. Add flour and mix well. Gradually stir in milk. Cook on High for 3 to 4 minutes. Stirring halfway through cooking. Add cheese and cook on High for a further 1 to 1½ minute. Stir and serve with vegetables of your choice.

MINT SAUCE

Makes: Approximately ¼ cup

Ingredients:

¼ cup water
 1 tablespoon sugar
 2 tablespoons brown vinegar
 2 tablespoons mint, finely chopped

Method:

Combine all ingredients in 1-cup jug. Cook on High for 30 to 60 seconds. Stir well and serve with Roast Lamb.

HOLLANDAISE SAUCE

Makes: ¾ cups

Ingredients:

60 g butter
 2 tablespoons lemon juice
 2 egg yolks
 ¼ cup cream
 ½ teaspoon mustard
 ¼ teaspoon salt

Method:

Place butter in a 2-cup jug. Cook on High for 40 seconds. Add lemon juice, egg yolks and cream. Mix well. Cook on Medium for 60 to 90 seconds. Add mustard and salt, mix until smooth. Serve with eggs, vegetables or fish dishes.

CREAMY BACON SAUCE

Makes: Approximately 300 ml

Ingredients:

1 onion, chopped
 3 bacon rashers, chopped
 1 teaspoon minced garlic
 300 ml cream
 ¼ cup Parmesan cheese
 pepper
 2 tablespoons chopped fresh parsley

Method:

Place onion, bacon and garlic in a 2-litre casserole dish. Cook on High for 4 to 5 minutes. Add cream, Parmesan cheese, pepper, parsley and stock. Mix well. Cook on High for 3 to 4 minutes. Serve with cooked Fettuccine.

RICH CHOCOLATE SAUCE

Makes: 1¼ cups

Ingredients:

200 g chocolate pieces
 300 ml cream

Method:

Combine chocolate and cream in a 1-litre jug. Cook on High for 2 minutes. Mix well. Serve over ice cream.

SWEET BERRY SAUCE

Makes: Approximately 2 cups

Ingredients:

½ cup caster sugar
 ½ cup water
 500 g berries
 2 tablespoons water
 1 tablespoon cornflour

Method:

Combine sugar and water in a 3-litre bowl. Cook on High for 2 to 3 minutes. Add berries. Cook on High for 3 to 4 minutes. Blend water and cornflour. Mix into berry sauce. Cook on High for 2 minutes. Serve hot or cold with ice cream.

HINT:

COOKING SAUCES:

When making some sauces in the microwave oven, less liquid may be needed as less evaporation occurs with a shorter cooking time.

STIRRED CUSTARD

Makes: Approximately 400 ml

Ingredients:

3 tablespoons	sugar
2 tablespoons	custard powder
1½ cups	milk
2	egg yolks, lightly beaten
1 teaspoon	vanilla essence

Method:

Combine sugar and custard powder in 4-cup jug. Gradually stir in milk until smooth. Cook on Med-High for 4 to 5 minutes, stirring halfway through cooking. Add egg yolks and mix well. Cook on Med-High for further 30 to 60 seconds. Add vanilla, stir well and serve.

HINT:**TO REHEAT POURING CUSTARD:**

Place 600 ml in a 1-litre jug and cook on High for 2 to 3 minutes stirring once.

COFFEE

Serves: 1

Ingredients:

1 cup	water
1 to 2 teaspoons	instant coffee

Method:

Pour water into a heatproof cup. Add coffee. Stir. Heat on High for 1 to 2 minutes. Add milk and sugar, if desired. Stir.

TEA

Serve: 2

Ingredients:

¾ cup	hot tap water
1	tea bag

Method:

Pour water into a heatproof cup. Heat on High for 1 to 2 minutes. Stir then submerge tea bag in water. Stand until desired strength is reached. Remove tea bag. Add milk and sugar, if desired. Stir.

HOT CHOCOLATE

Serve: 1

Ingredients:

1 tablespoon	choc bits
250 ml	milk

Method:

Place choc bits in the base of a mug add milk. Cook on Med-High for 2 minutes, stirring half way through cooking. Stir and serve.

PEPPERMINT COOLER

Serve: 4

Ingredients:

3	peppermint tea bags
4 cups	cold water
	juice of ½ lemon
	ice blocks
4 slices	lemon or lime
	mint leaves to garnish

Method:

Place tea bags and water in a large jug. Cook on High for 8 to 10 minutes. Stand for 2 to 3 minutes, then discard tea bags. Cool. Add lemon juice. Refrigerate until well chilled. Serve in long glasses with ice blocks. Garnish with lemon or lime slices and mint leaves.

STRAWBERRY LIQUEUR

Makes: 1 liter

Ingredients:

500 g	sugar
500 g	washed and hulled strawberries
600 g	brandy or whisky

Method:

Place sugar and strawberries in a 4-litre dish. Stir well. Cook on High for 15 minutes. Stir in brandy or whisky. Pour into an airtight container. Store refrigerated for 2 to 3 months. Serve in liqueur glasses or as a tall drink with ice cubes and soda water.

COFFEE LIQUEUR

Makes: 750 ml

Ingredients:

1½ cups	hot tap water
2 cups	sugar
⅓ cup	freeze dried coffee
3 teaspoons	vanilla essence
2 cups	vodka

Method:

Pour water into a 4-litre casserole dish. Add remaining ingredients (except vodka) and stir well. Cook on Medium for 30 to 35 minutes. Cool slightly and mix in vodka. Pour into an airtight container and stand 4 days before serving. Serve in liqueur glasses.

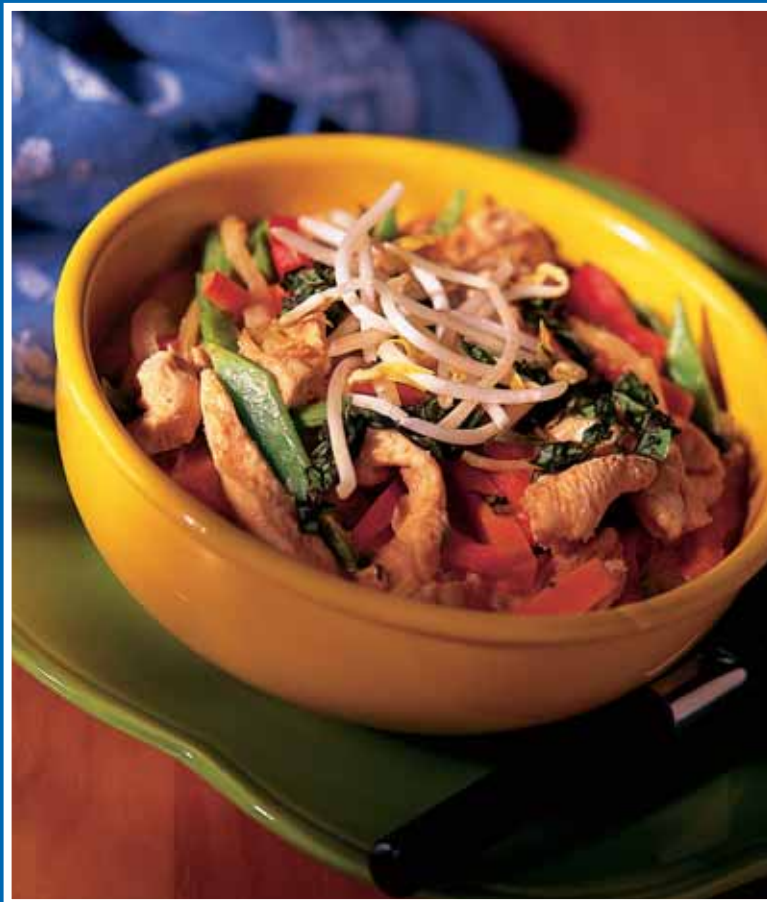
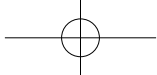

© Panasonic Appliances Microwave Oven (Shanghai) Co., Ltd. 2014

F0003BN60QP
PA0814-0
Printed in China

